



Revealing the Interior

*Private Screen
Parametrics Final Presentation*

Junyu Cao Qiao Ding Wanting She



Inspirations

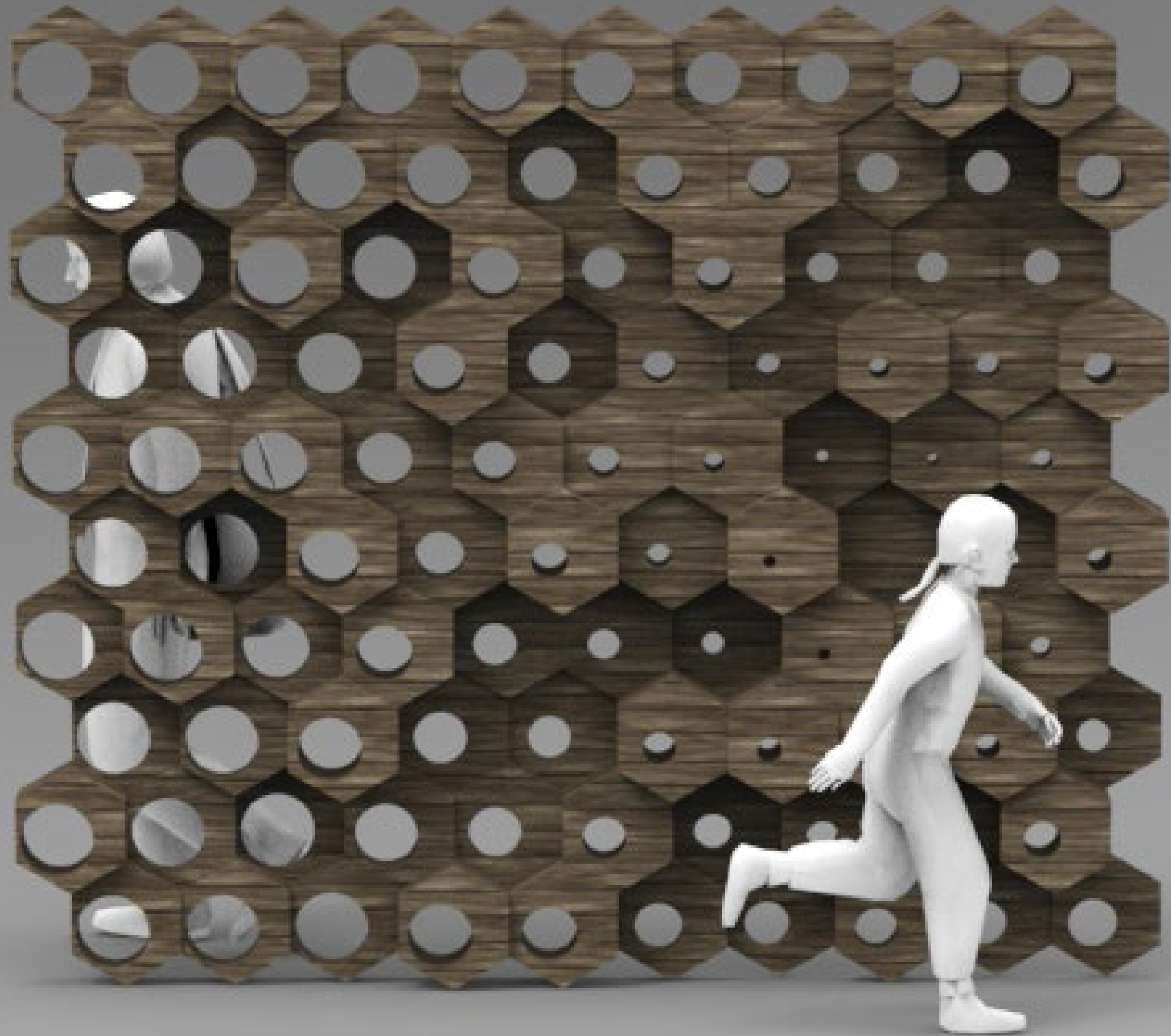

Process

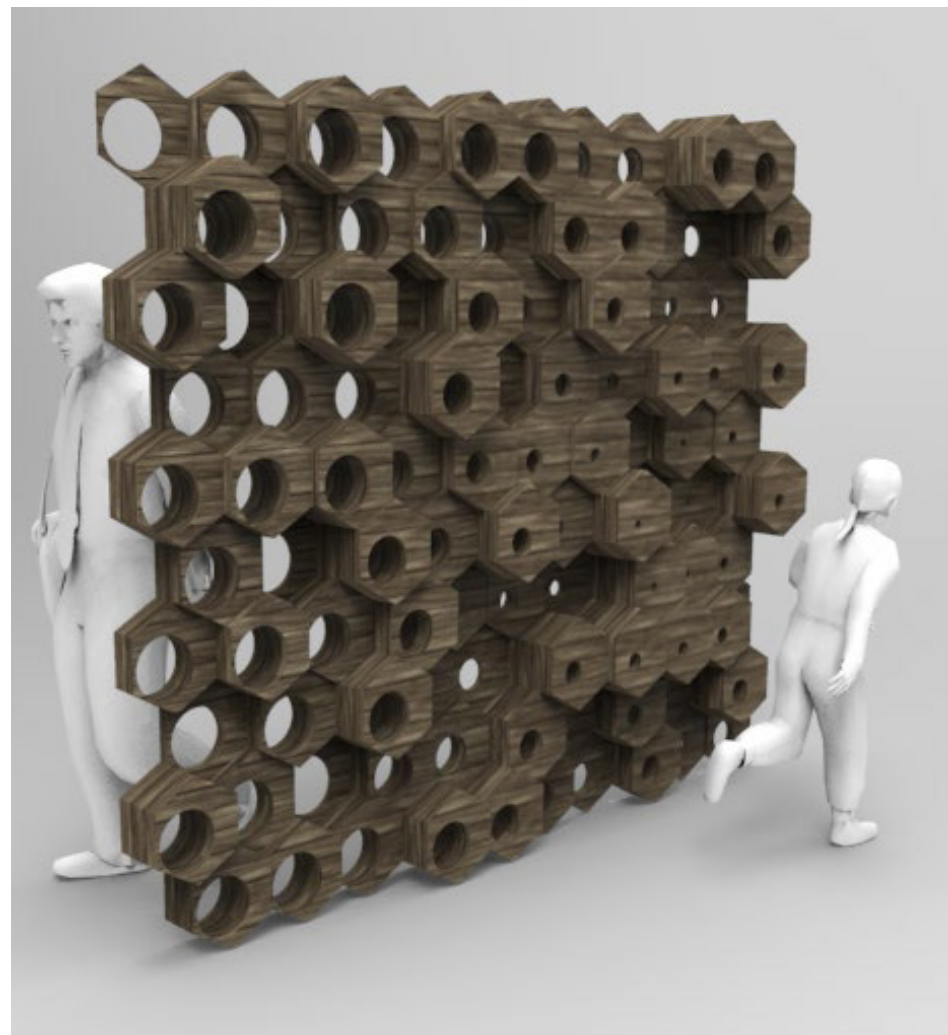
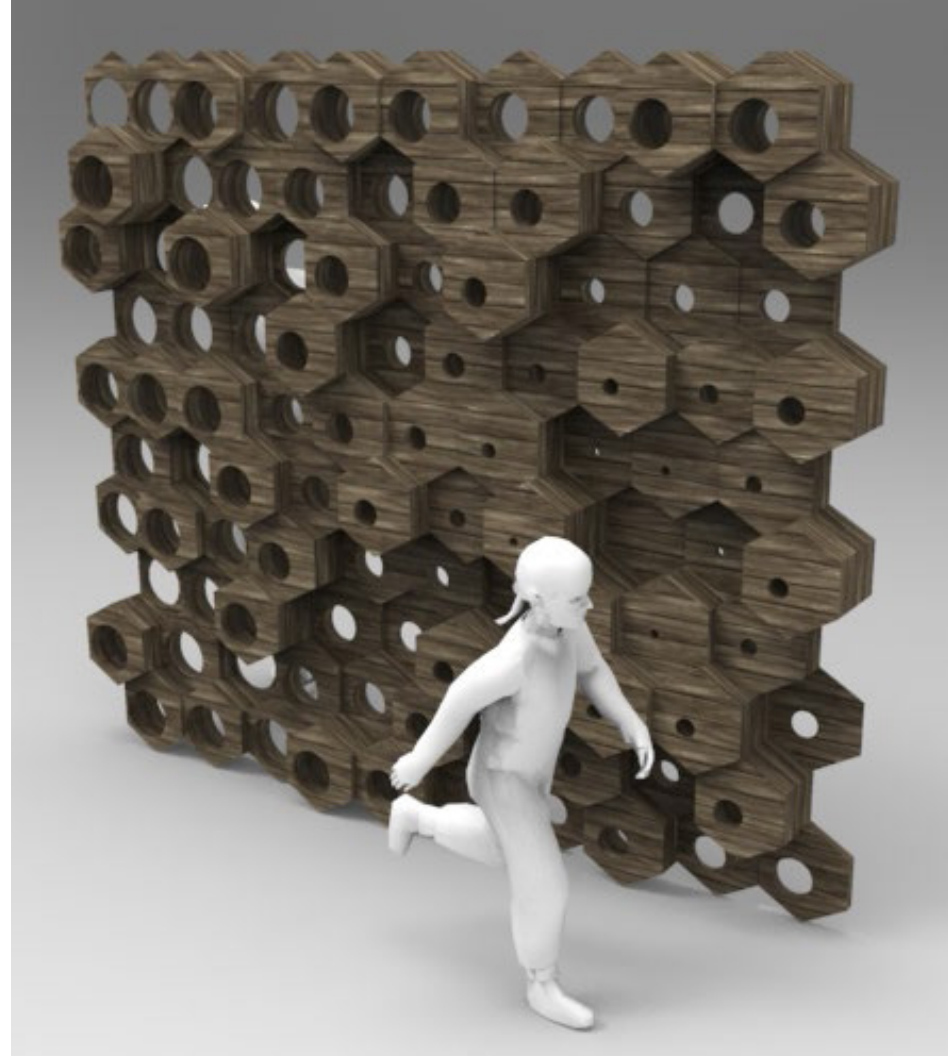

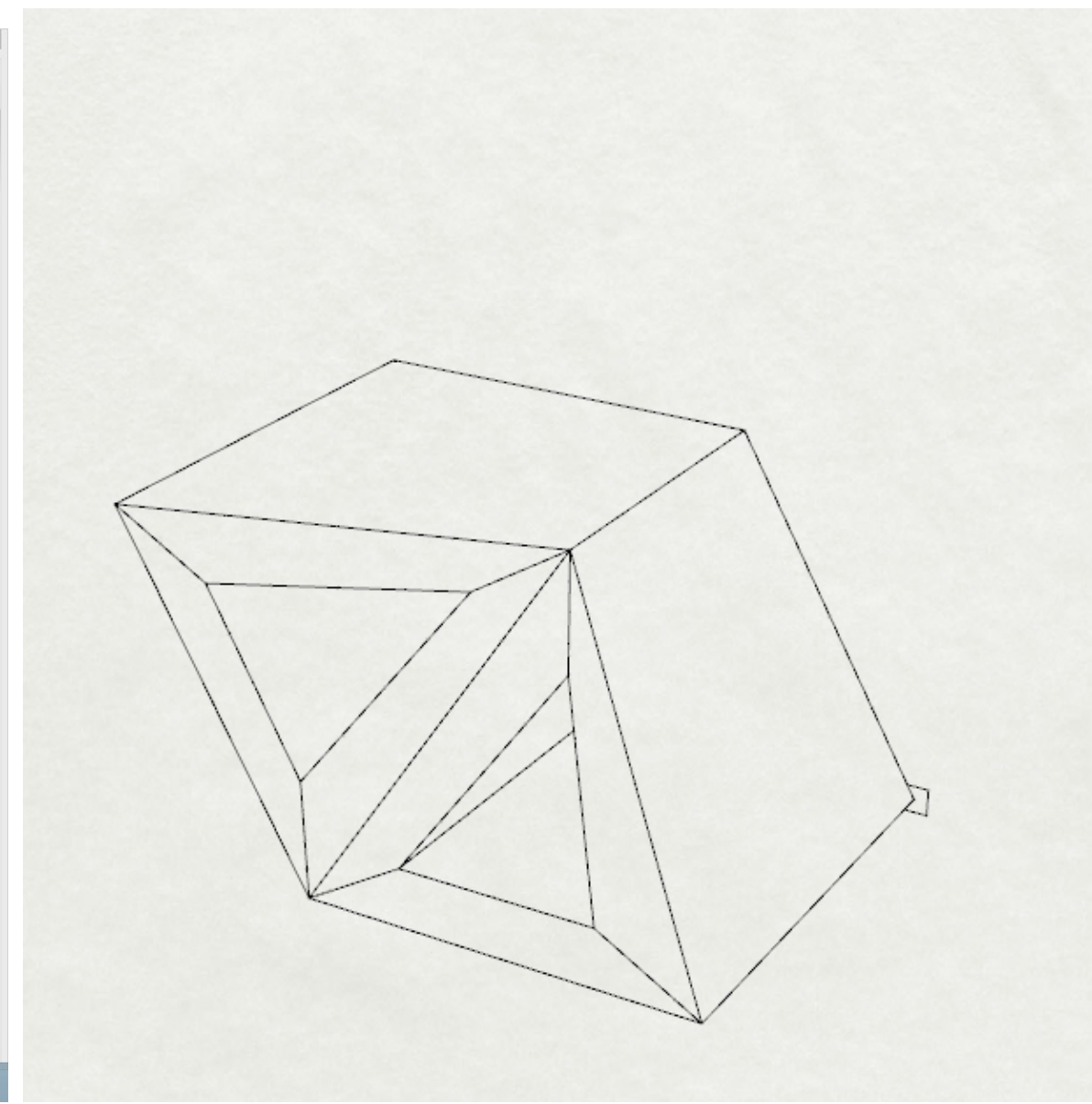
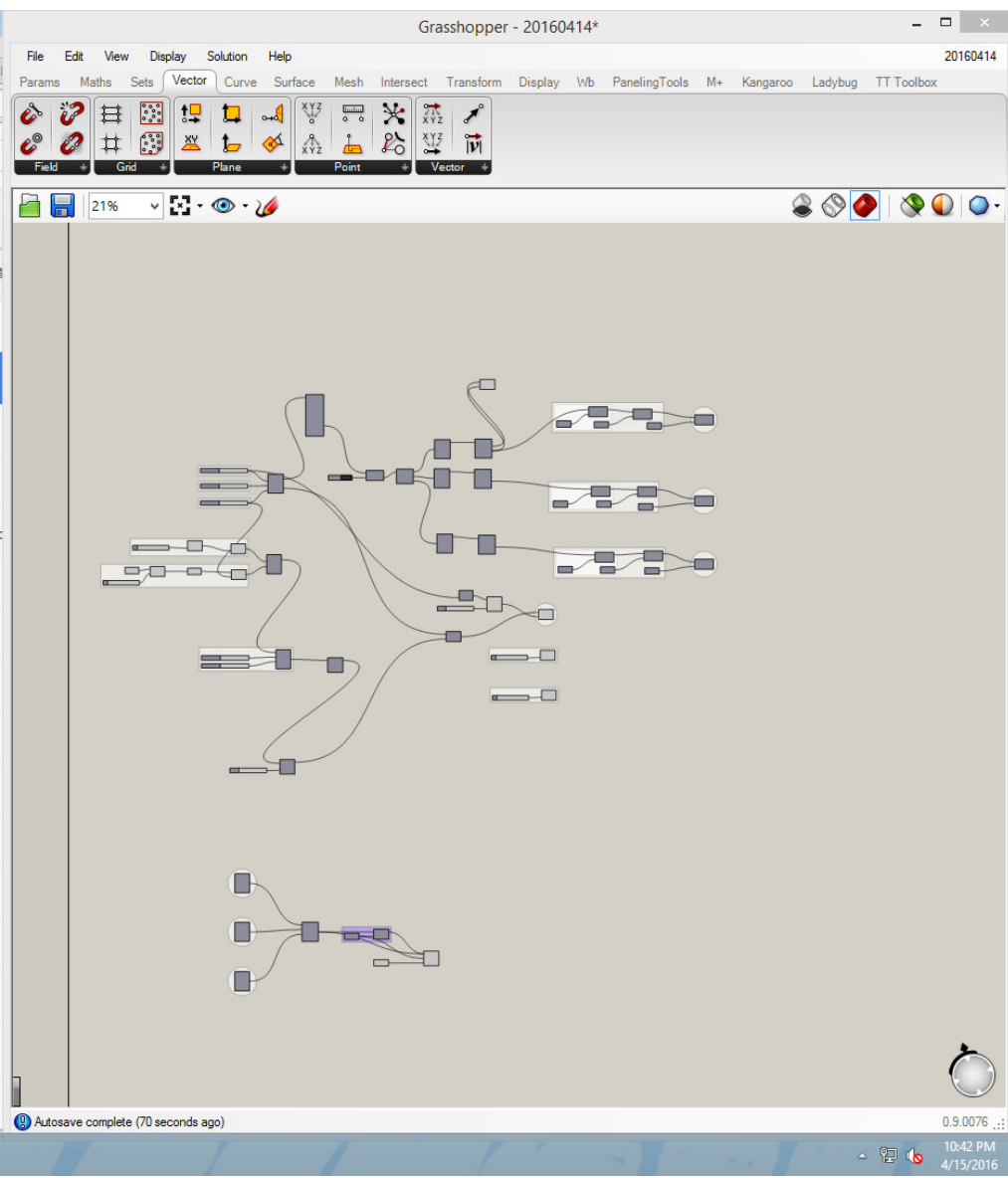
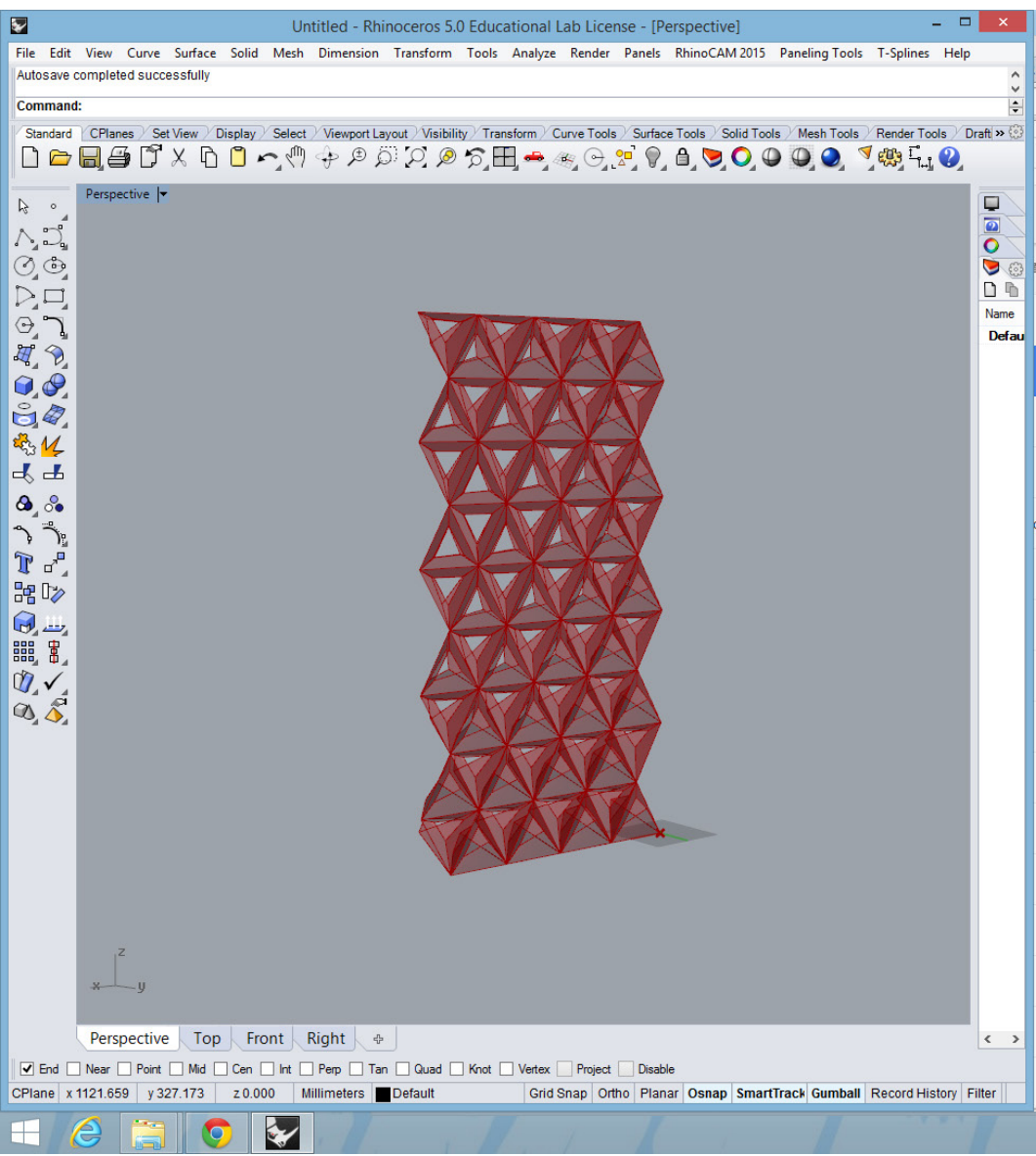

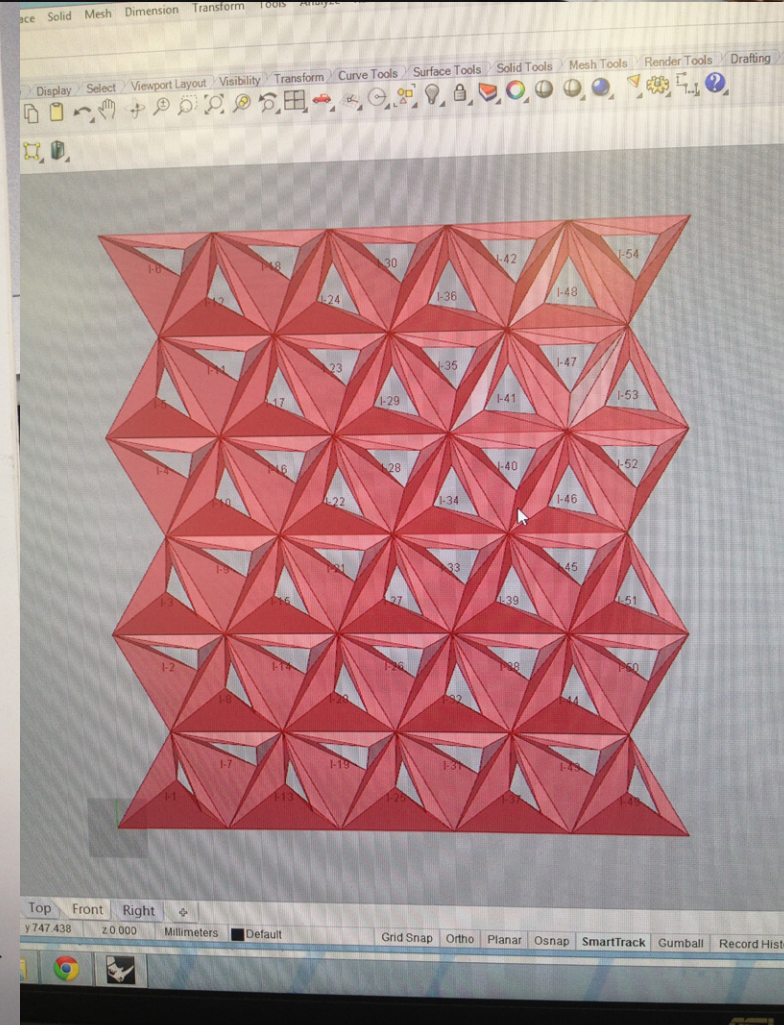
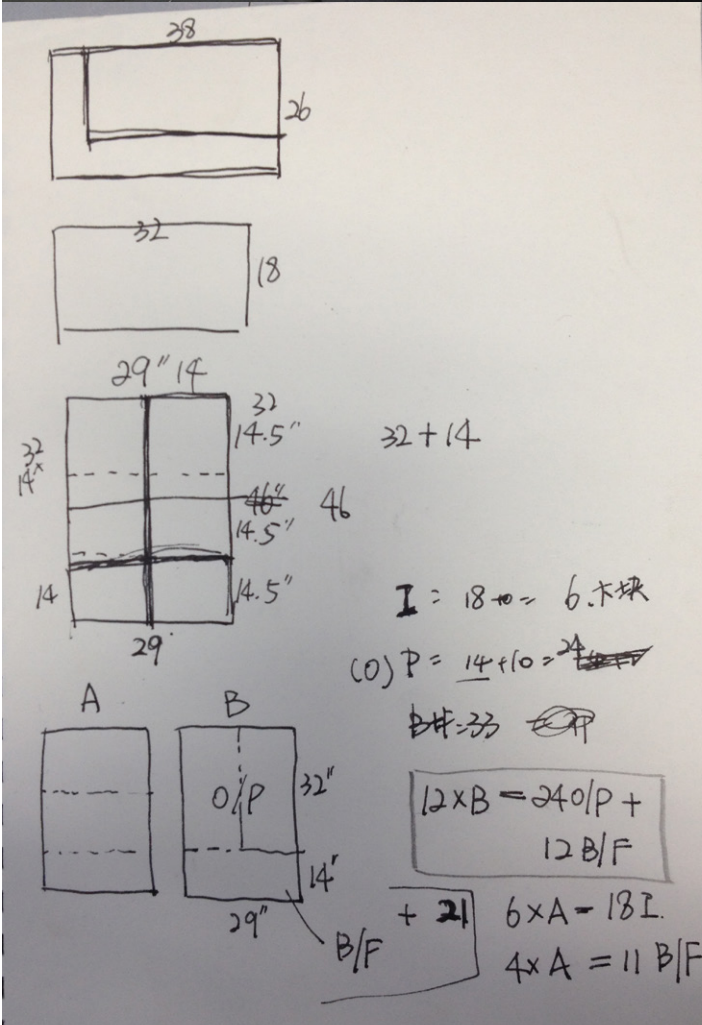
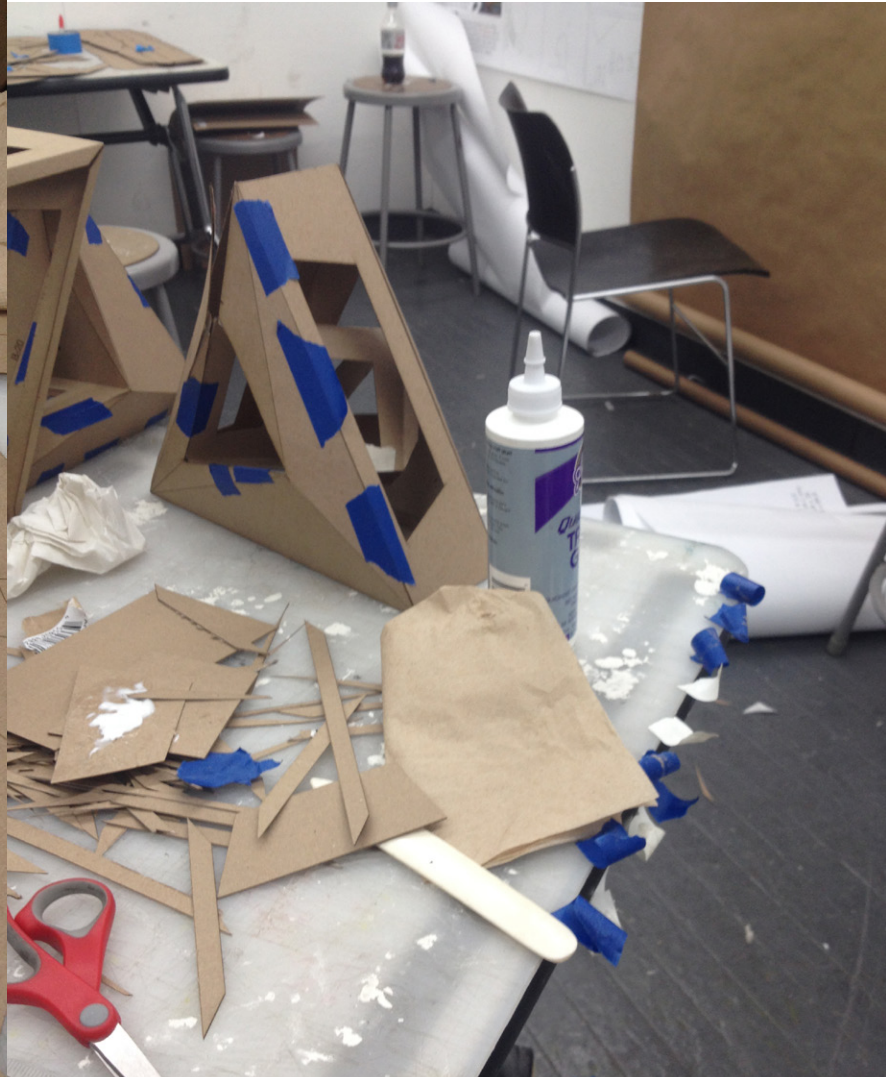
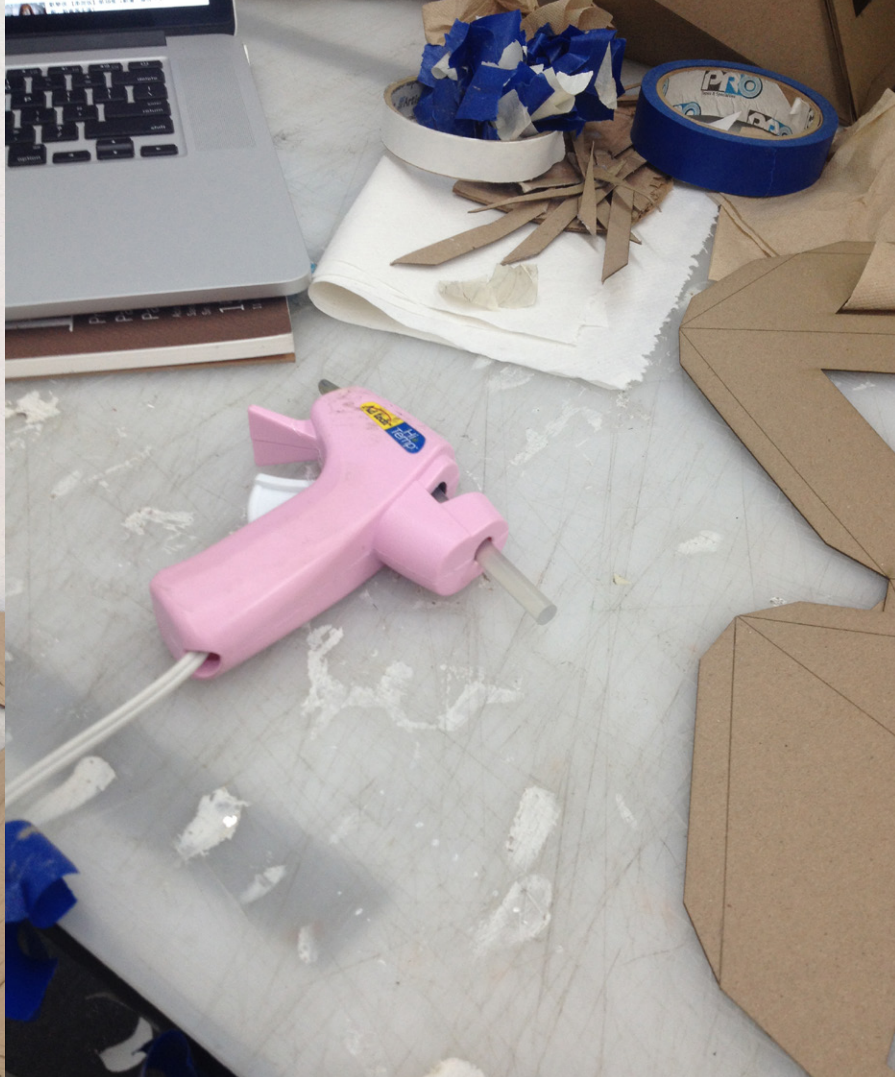

Fabrication

Definition

● *Variables*

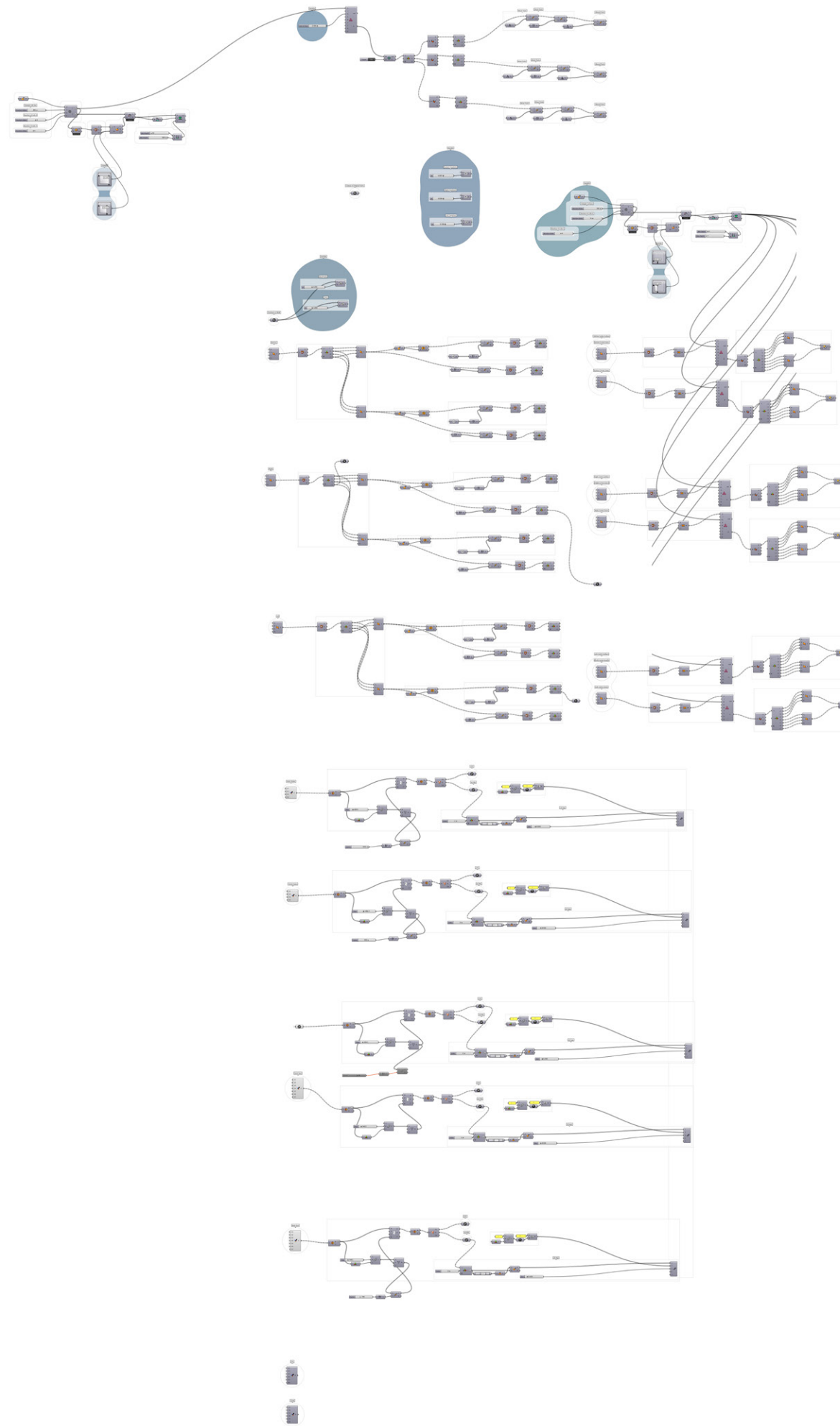

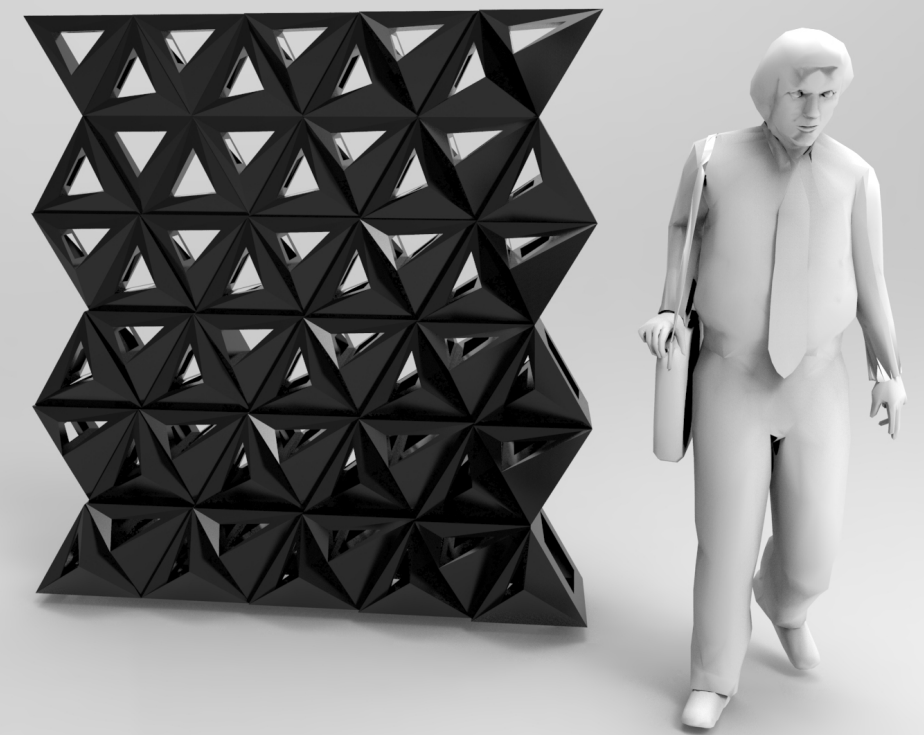
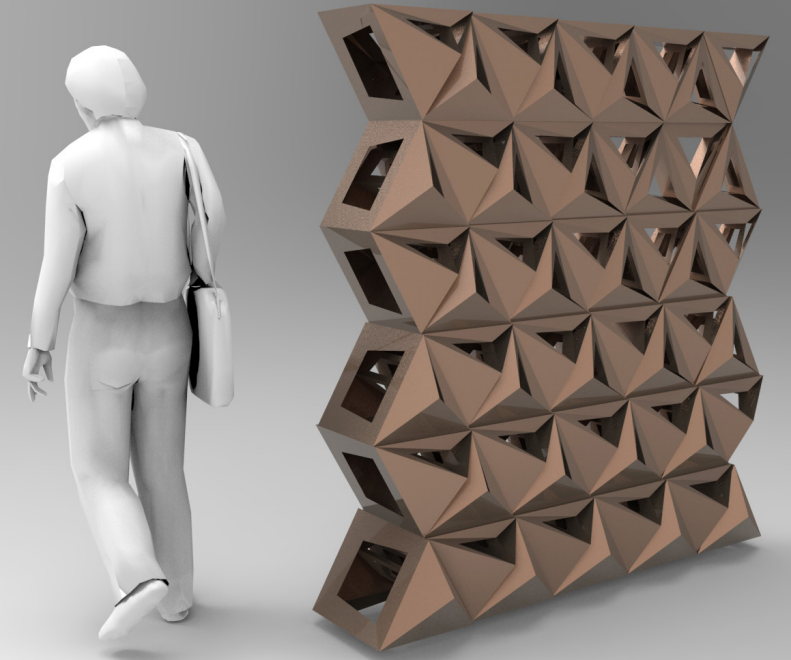
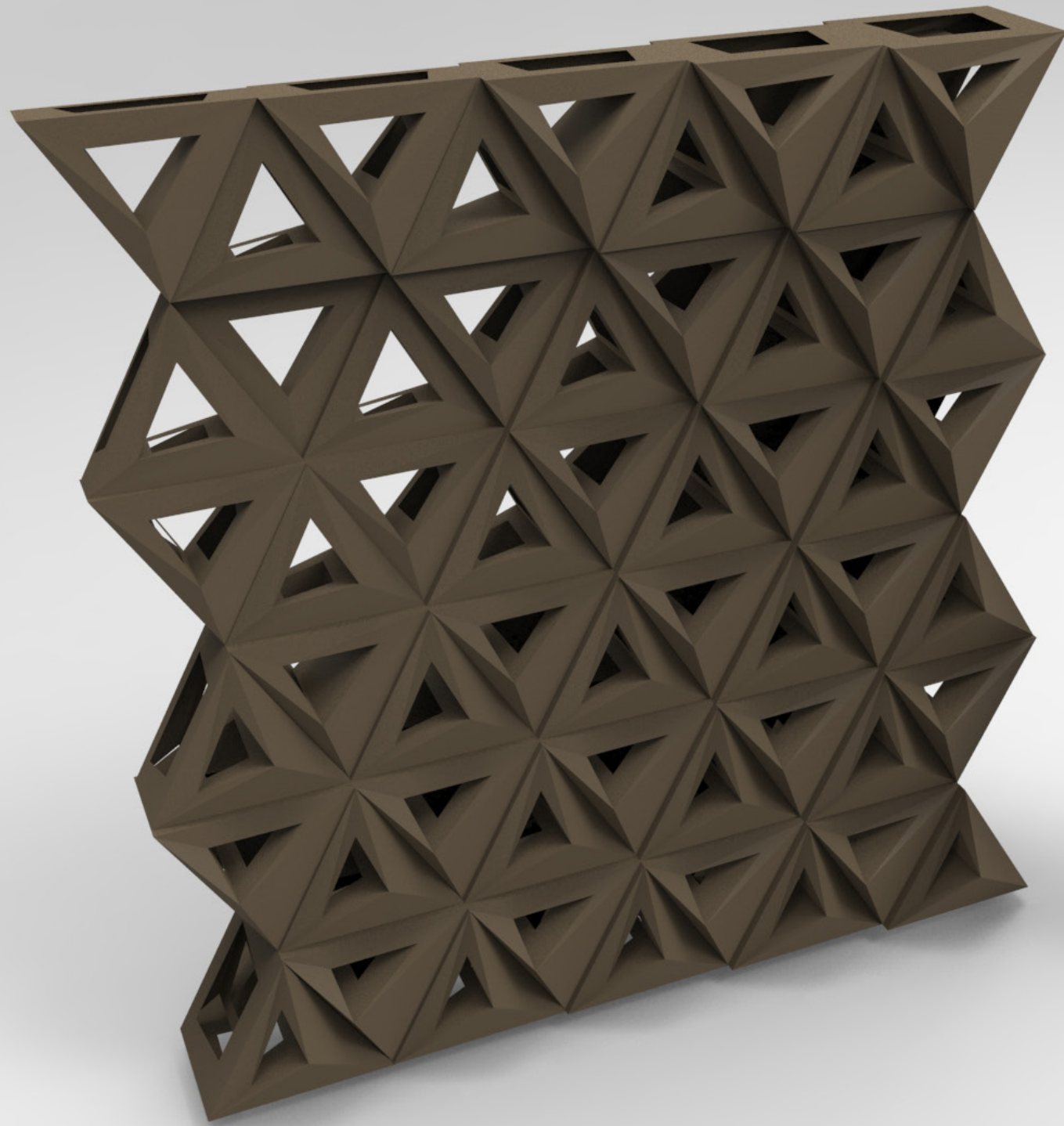

Full Wall

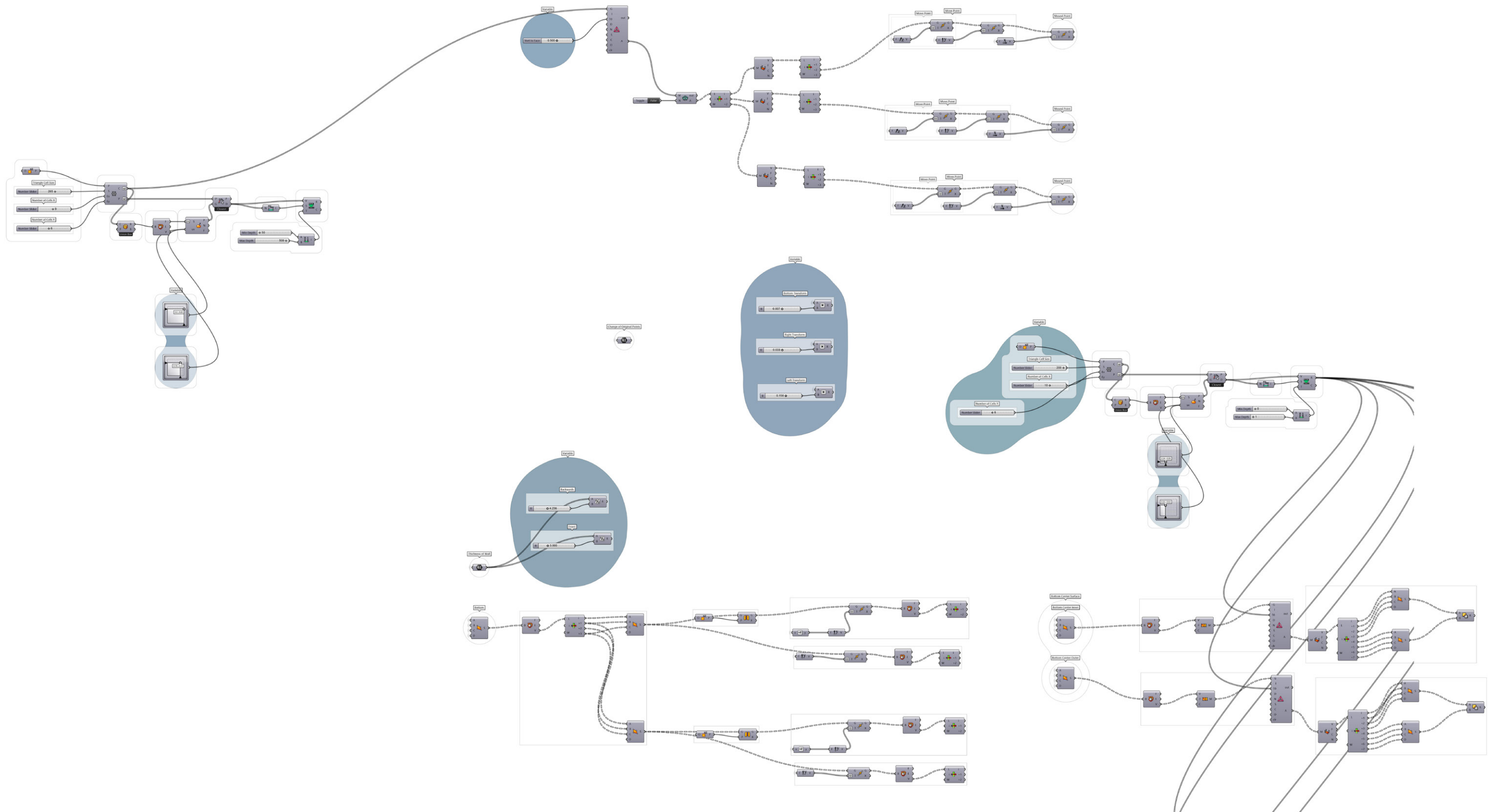

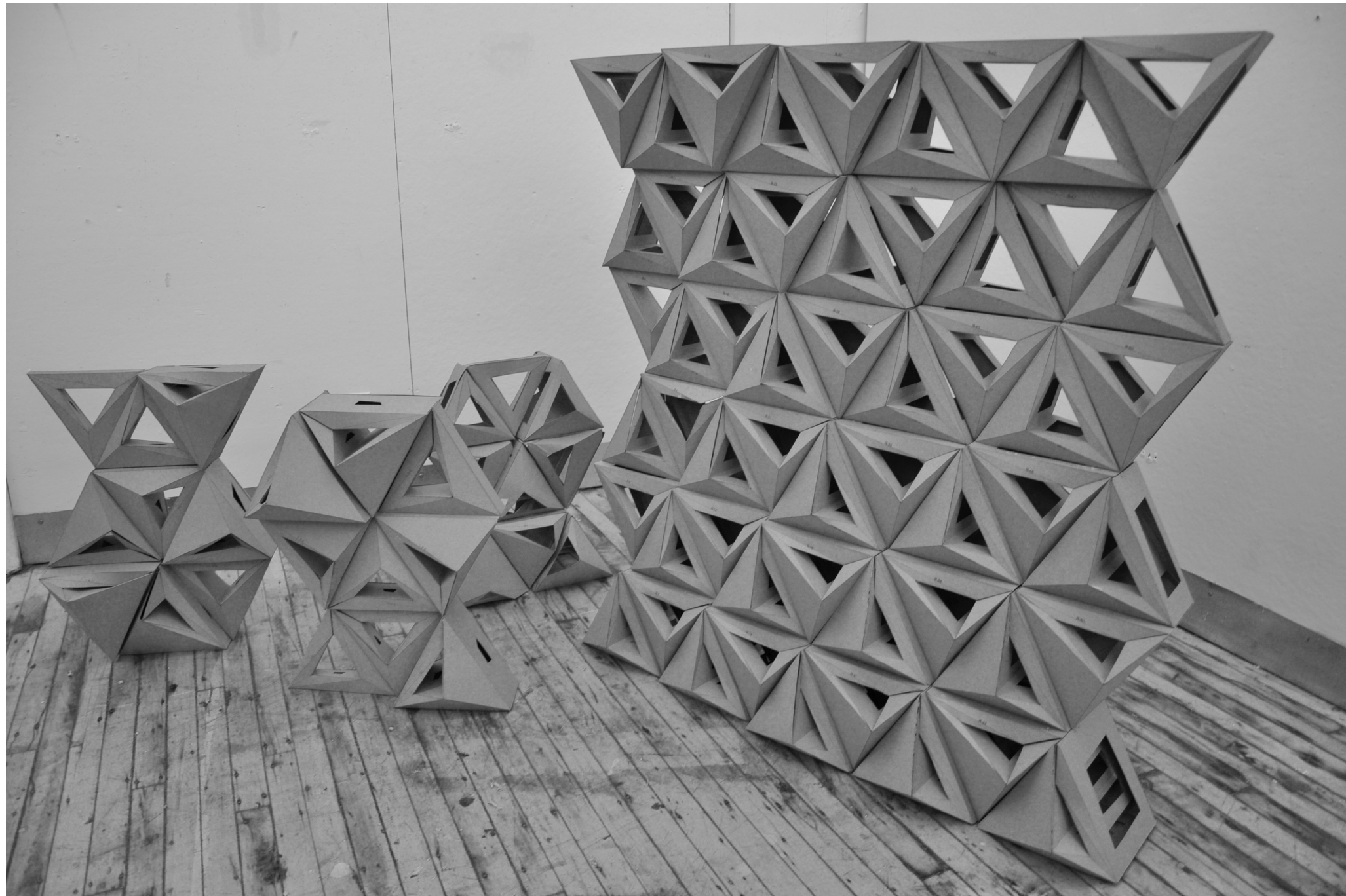

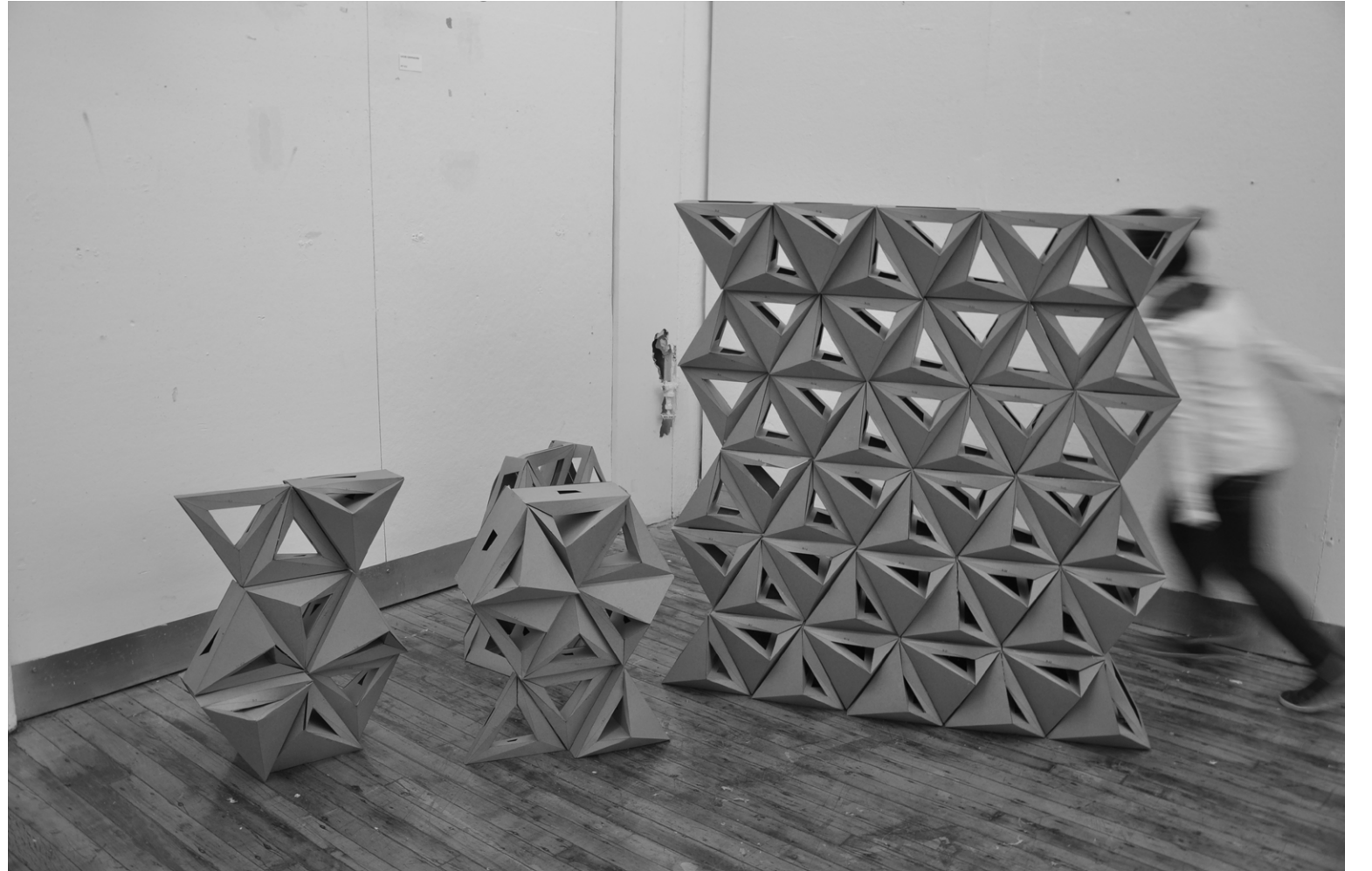
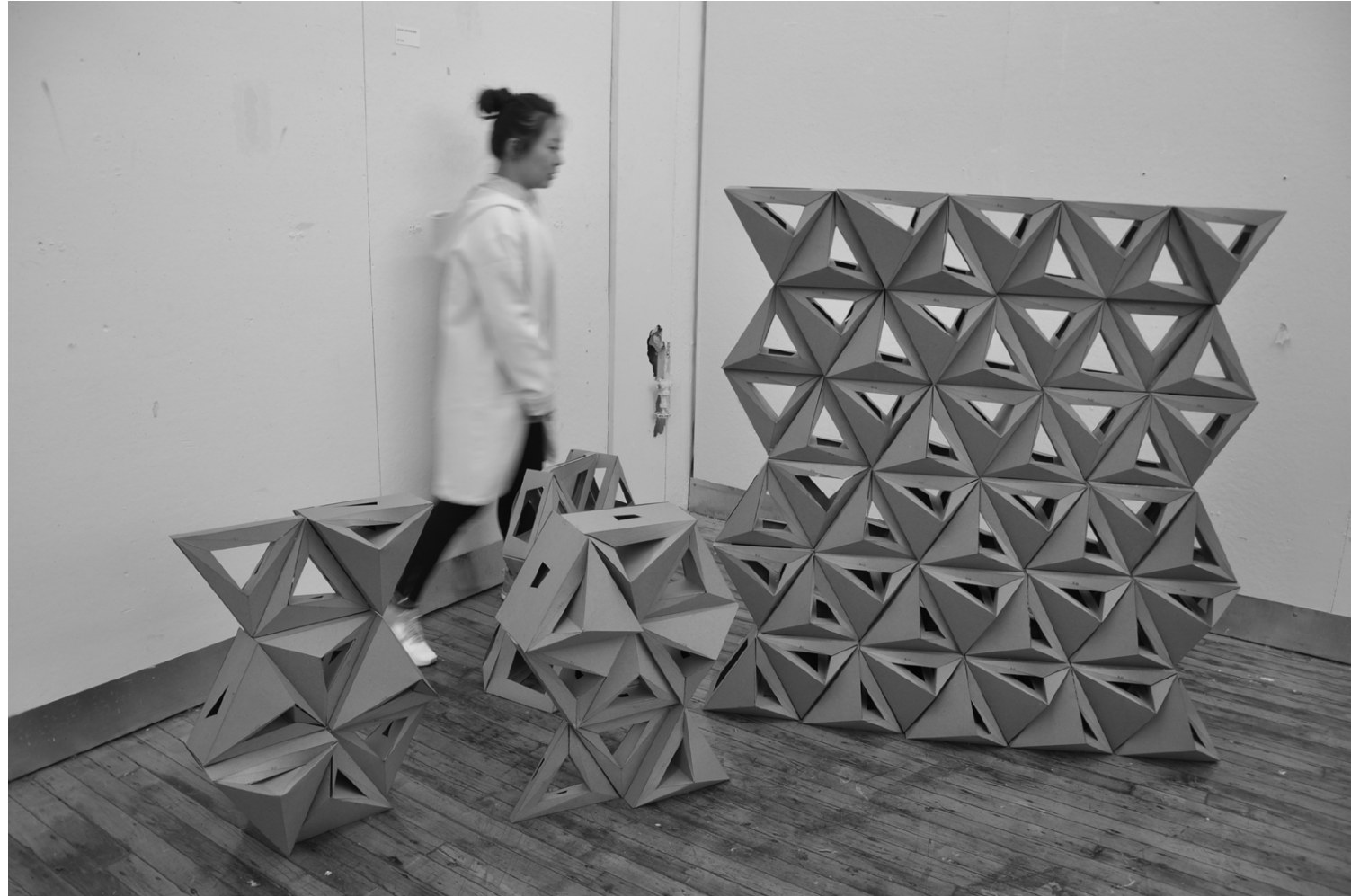

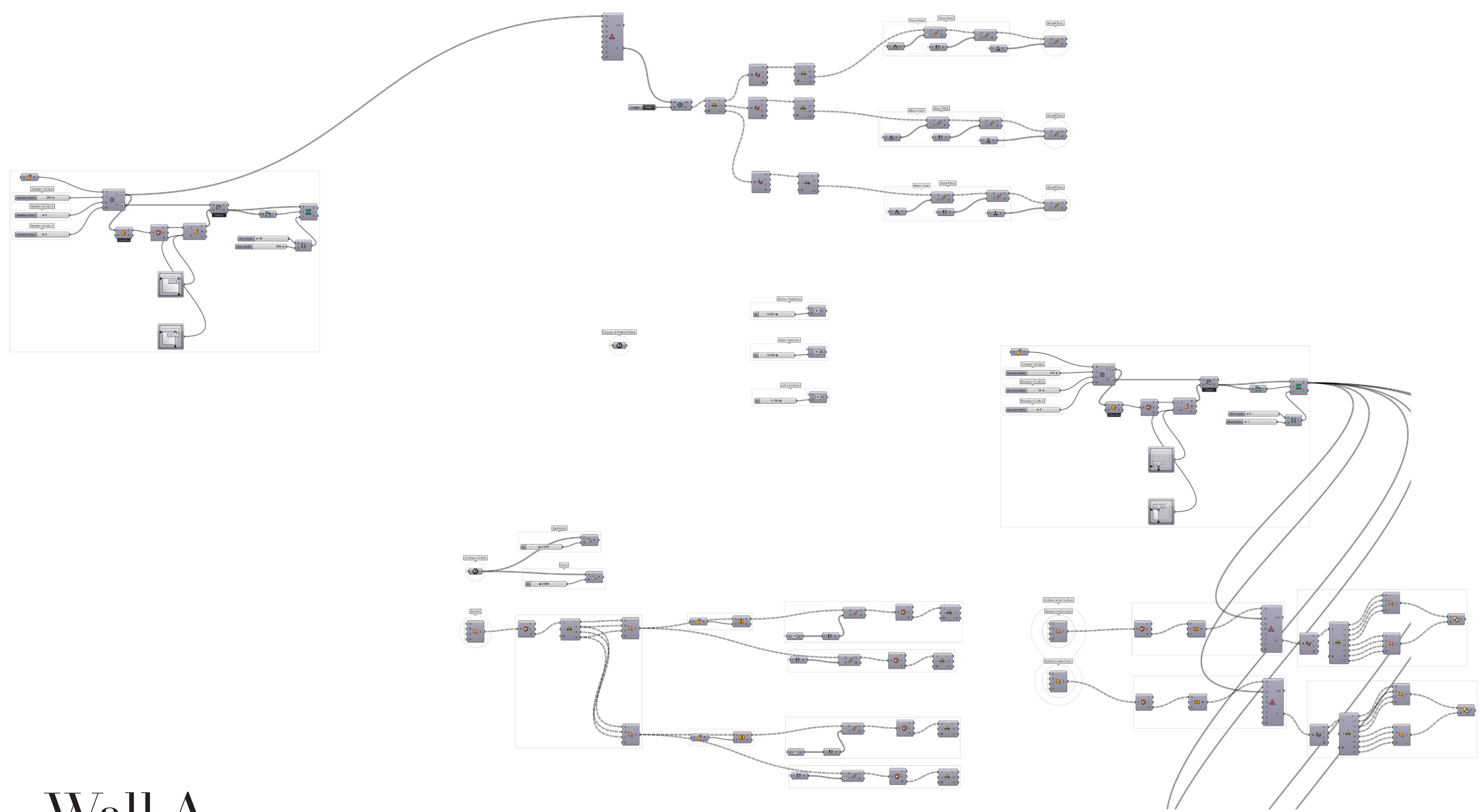

Wall A

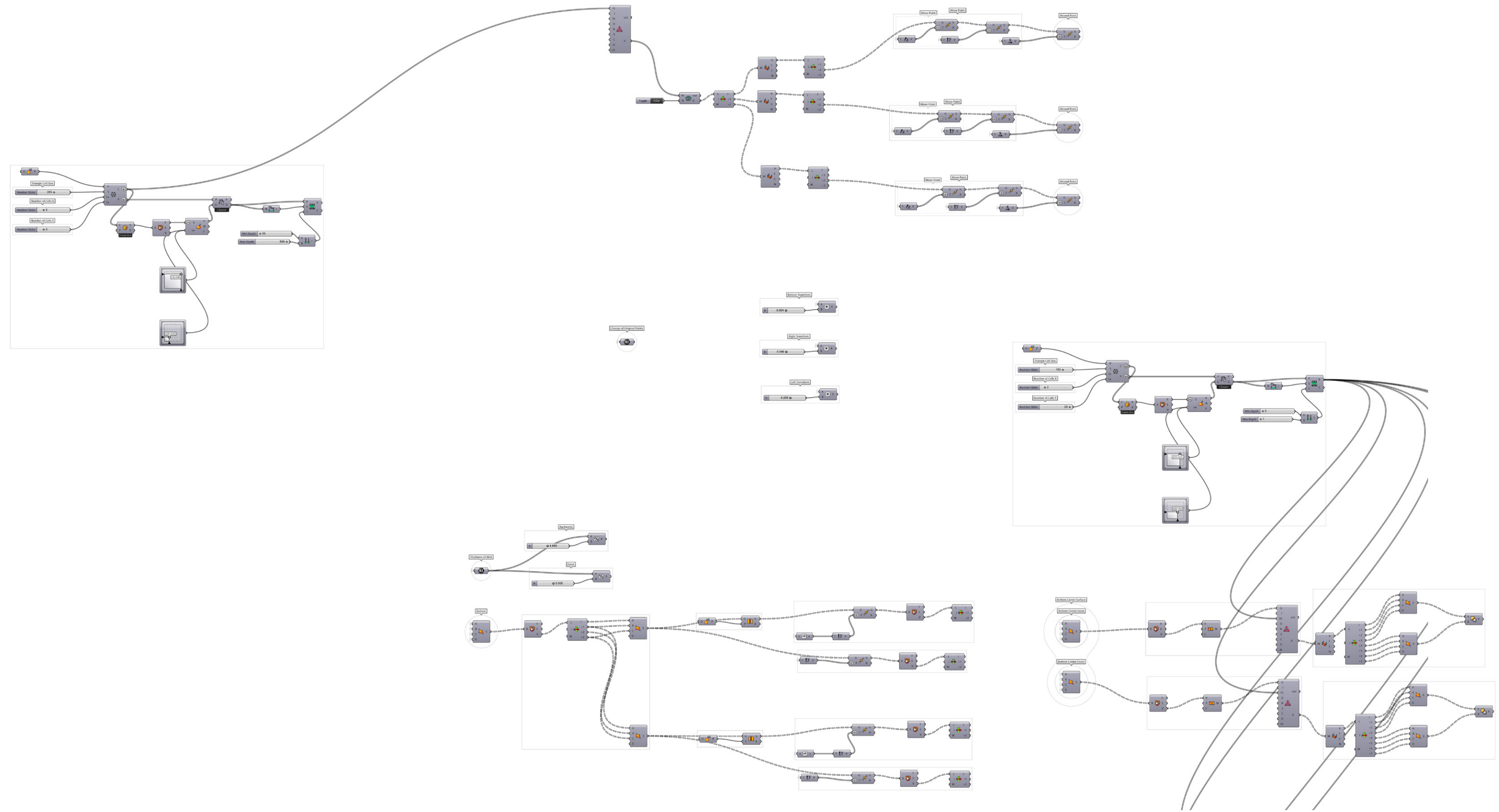

Wall B

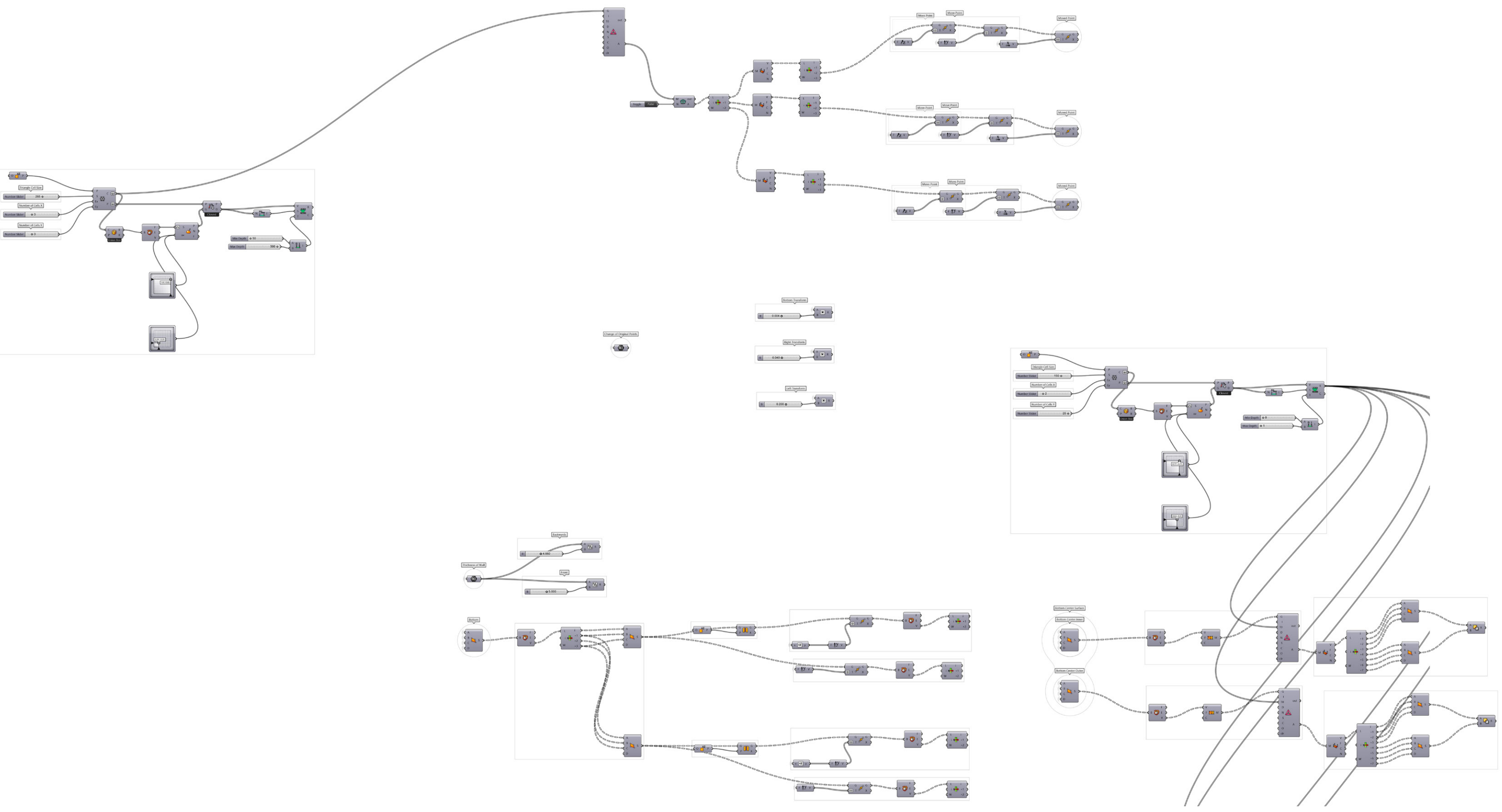

Wall C

5 Variations #1

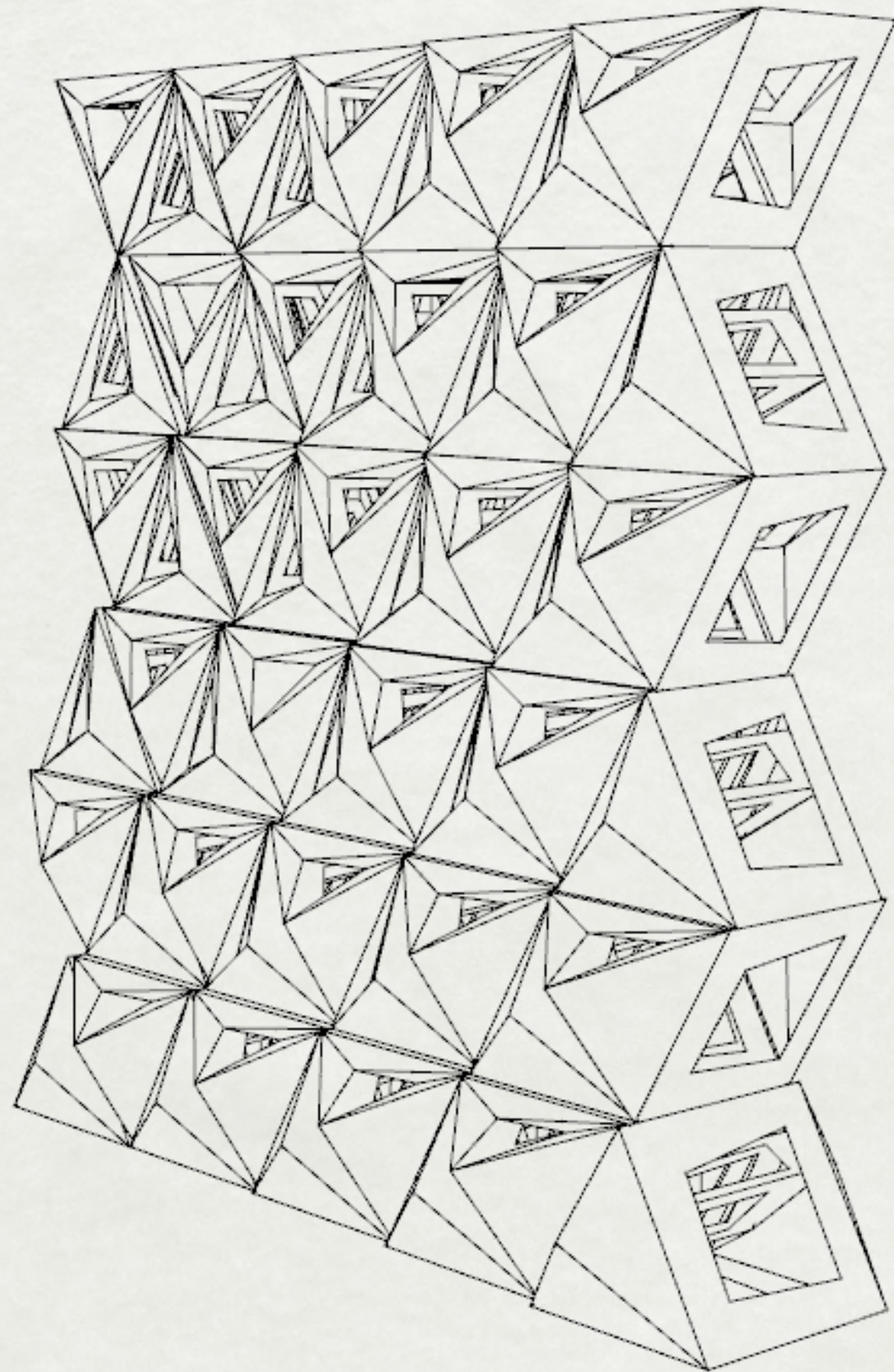

Perspective

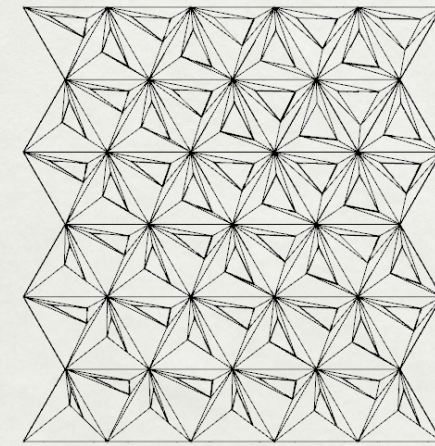

Front

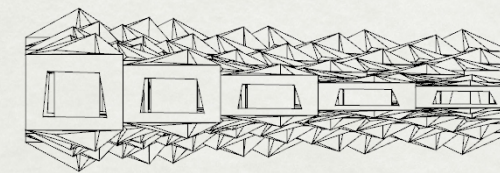

Top

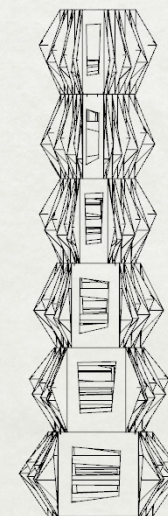

Side

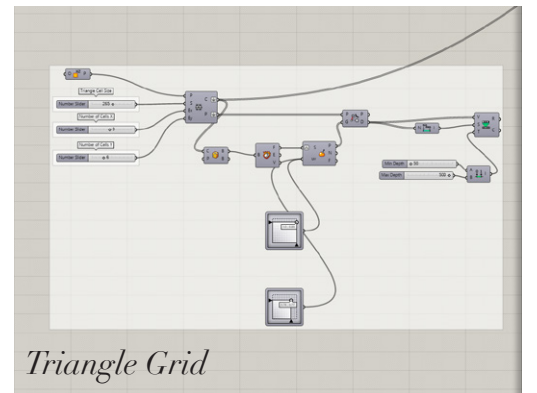

Triangle Grid

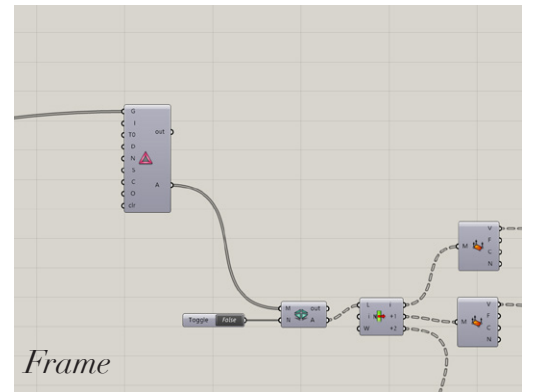

Frame

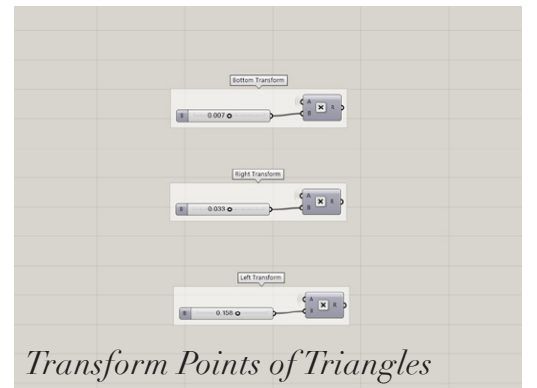

Transform Points of Triangles

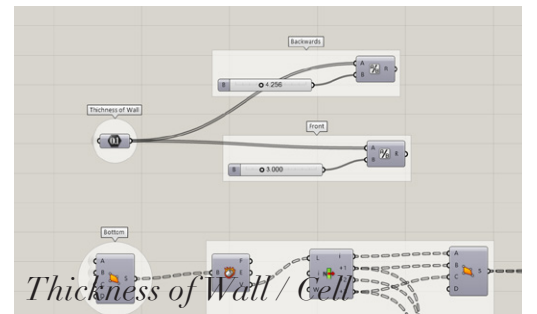

Thickness of Wall / Cell

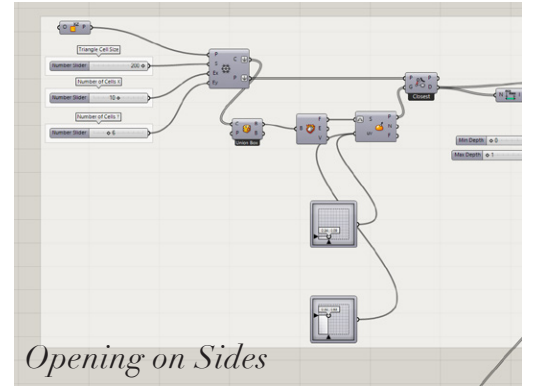

Opening on Sides

5 Variations #2

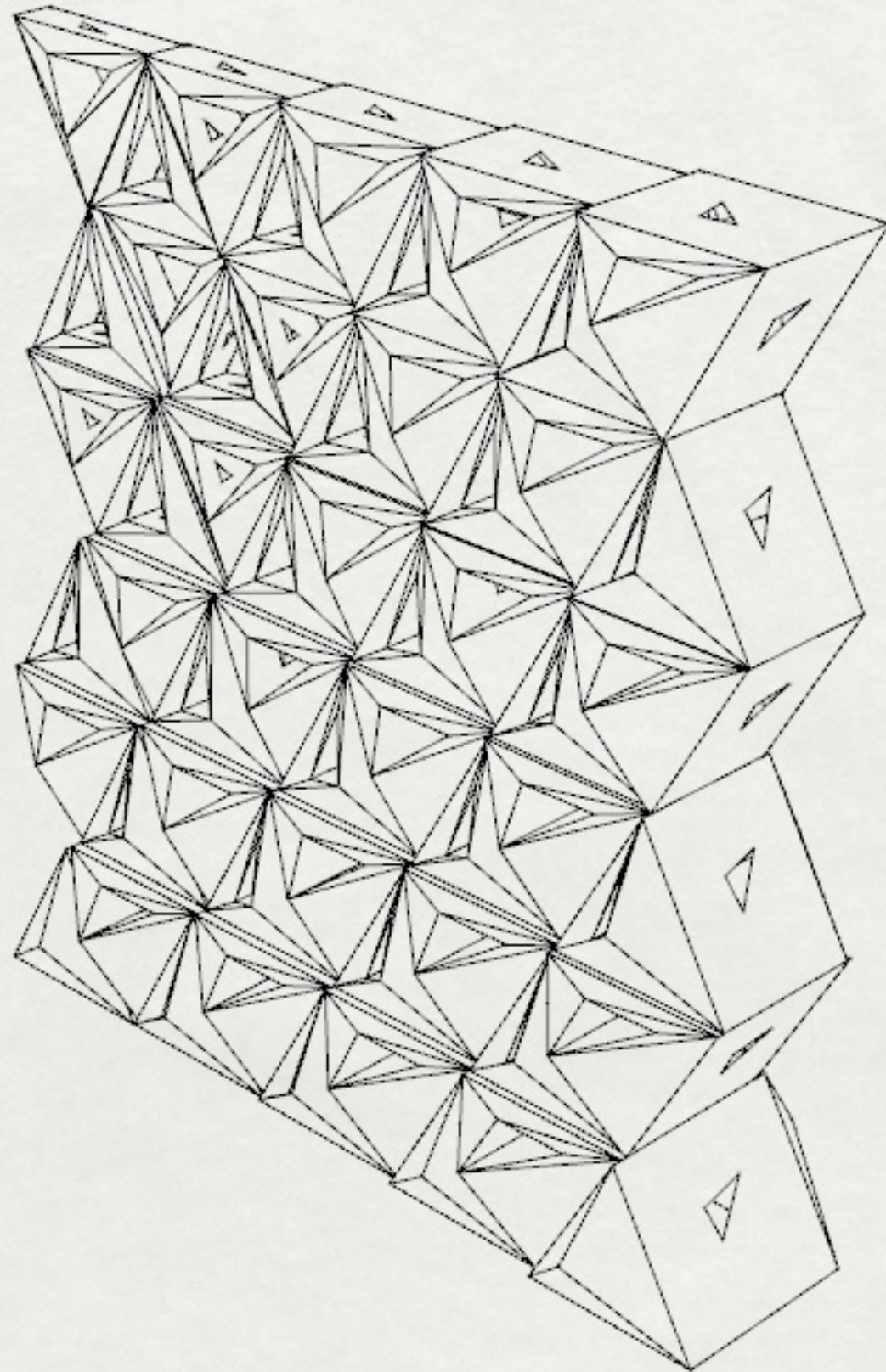

Perspective

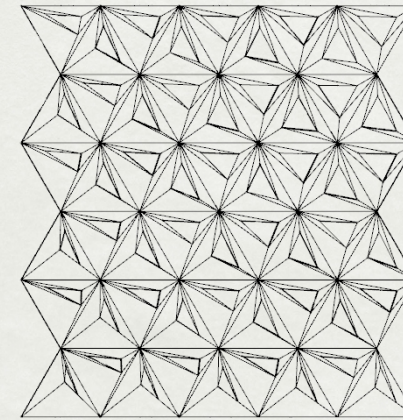

Front

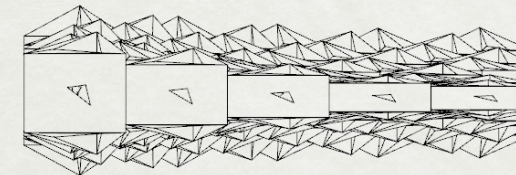

Top

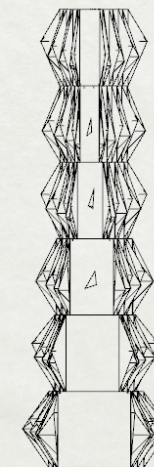

Side

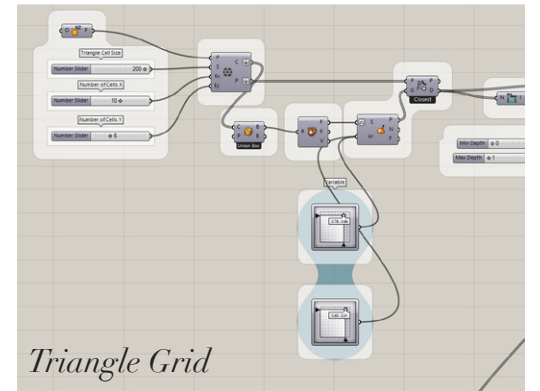

Triangle Grid

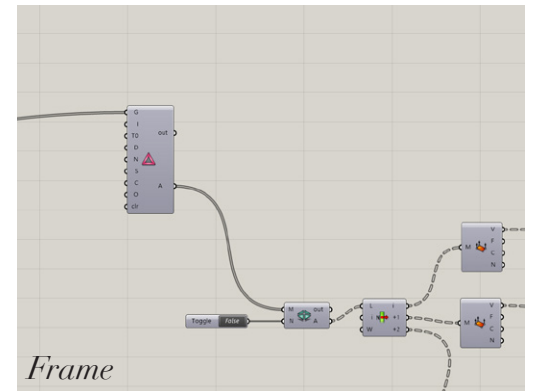

Frame

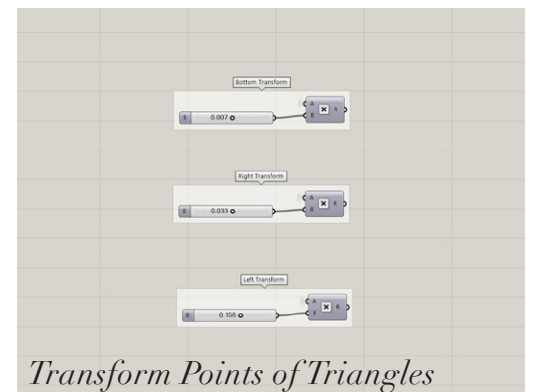

Transform Points of Triangles

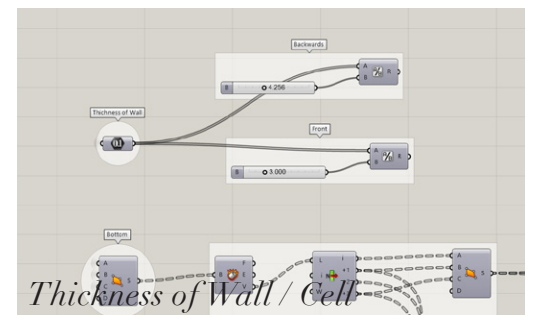

Thickness of Wall / Cell

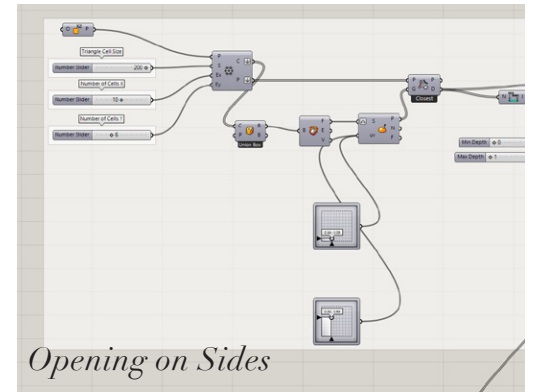

Opening on Sides

5 Variations #3

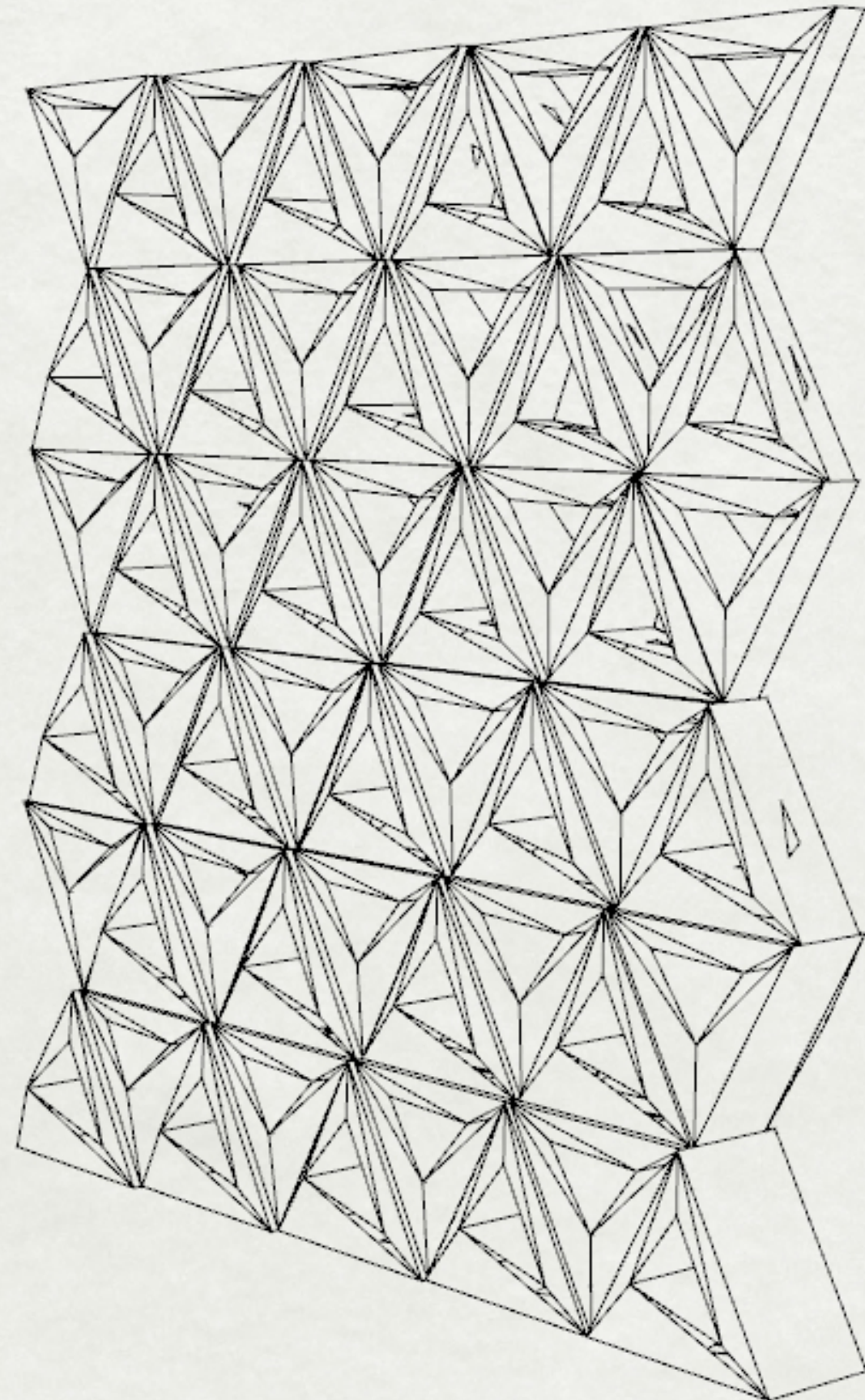

Perspective

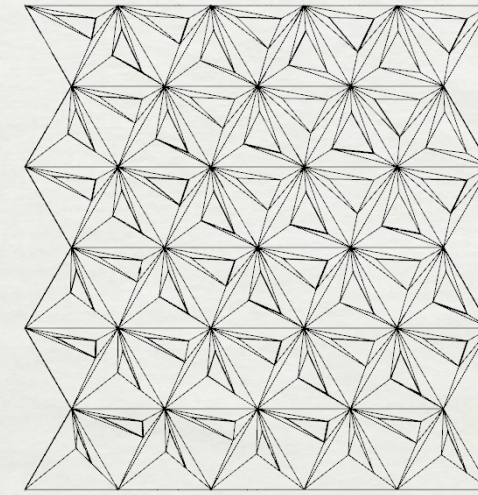

Front

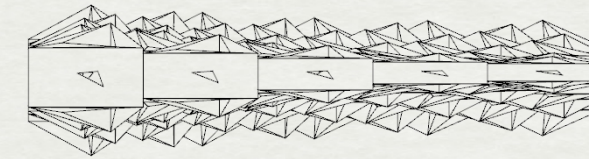

Top

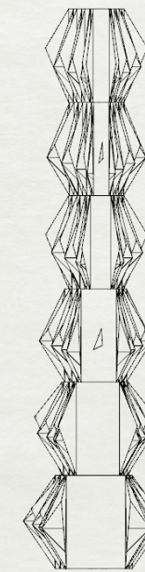

Side

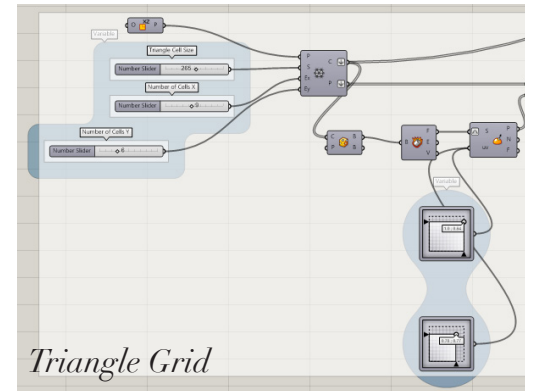

Triangle Grid

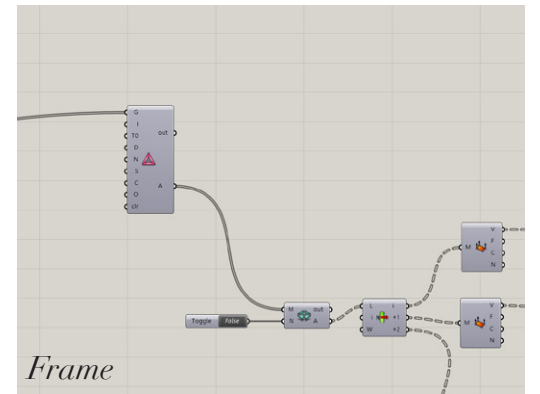

Frame

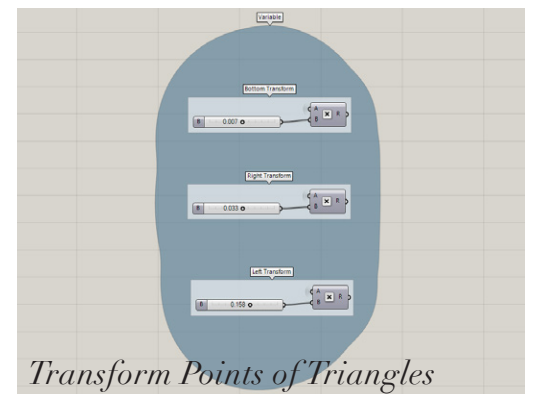

Transform Points of Triangles

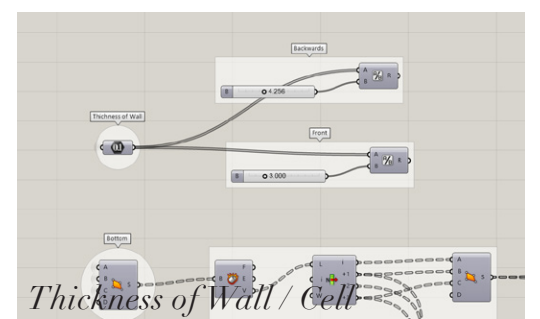

Thickness of Wall / Cell

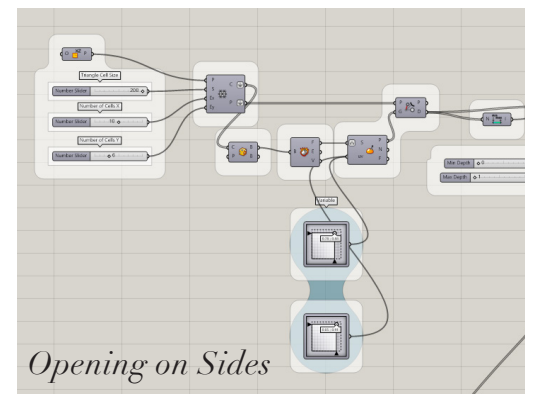

Opening on Sides

5 Variations #4

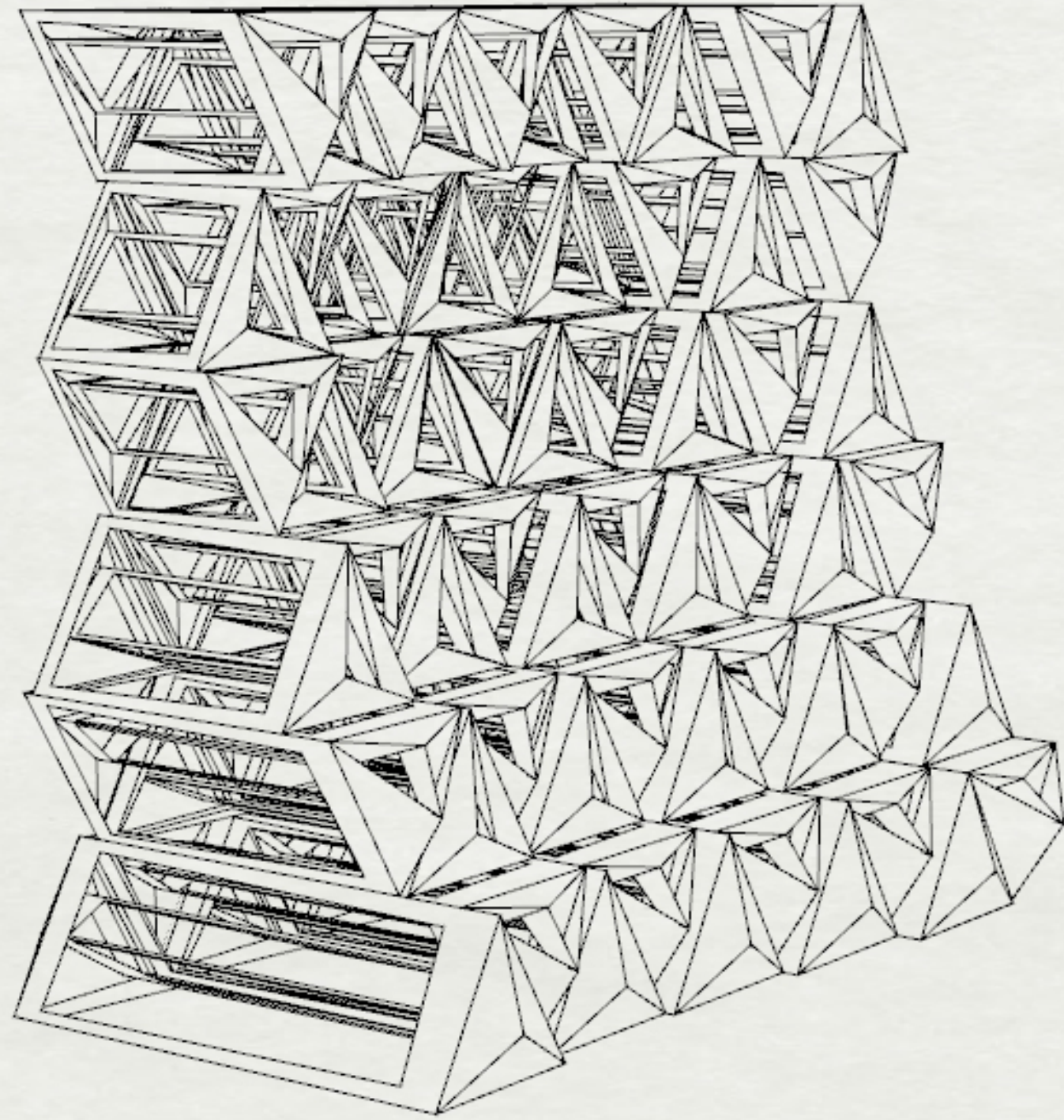

Perspective

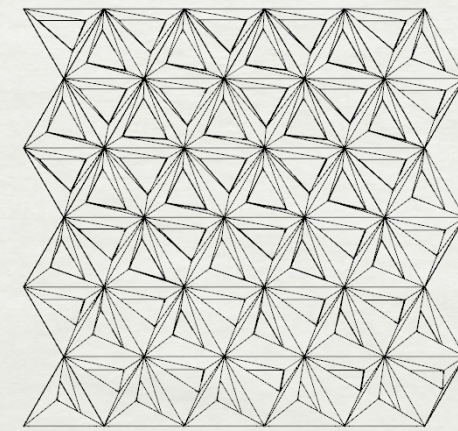

Front

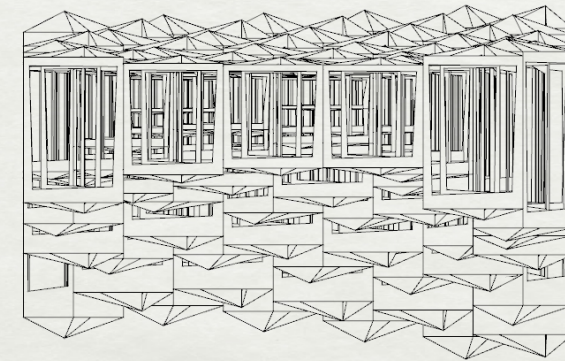

Top

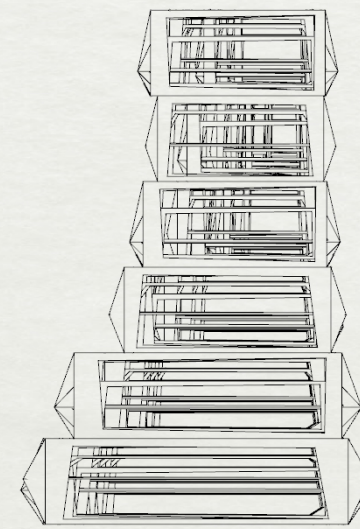

Side

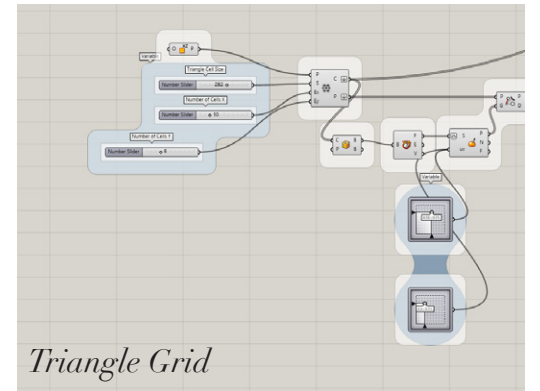

Triangle Grid

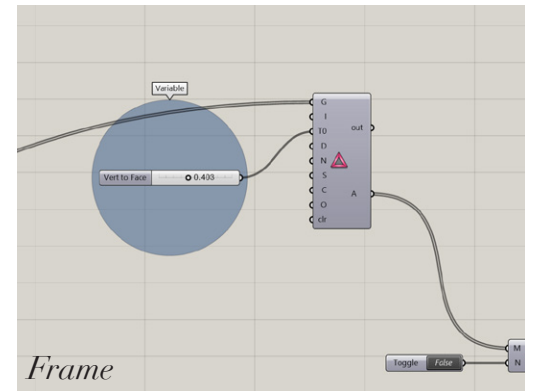

Frame

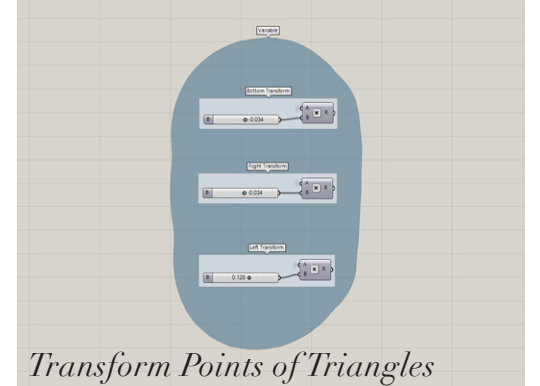

Transform Points of Triangles

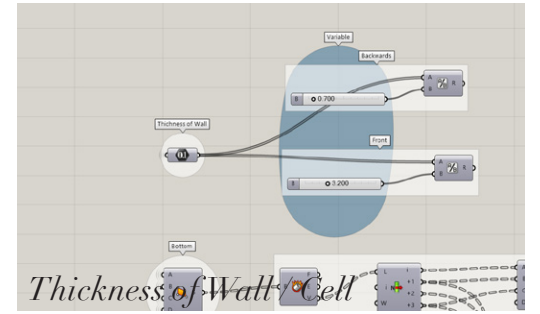

Thickness of Wall of Cell

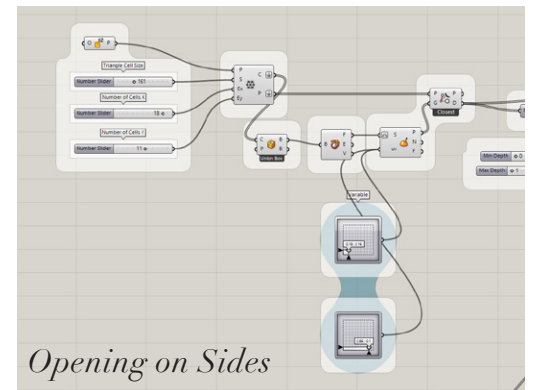

Opening on Sides

5 Variations #5

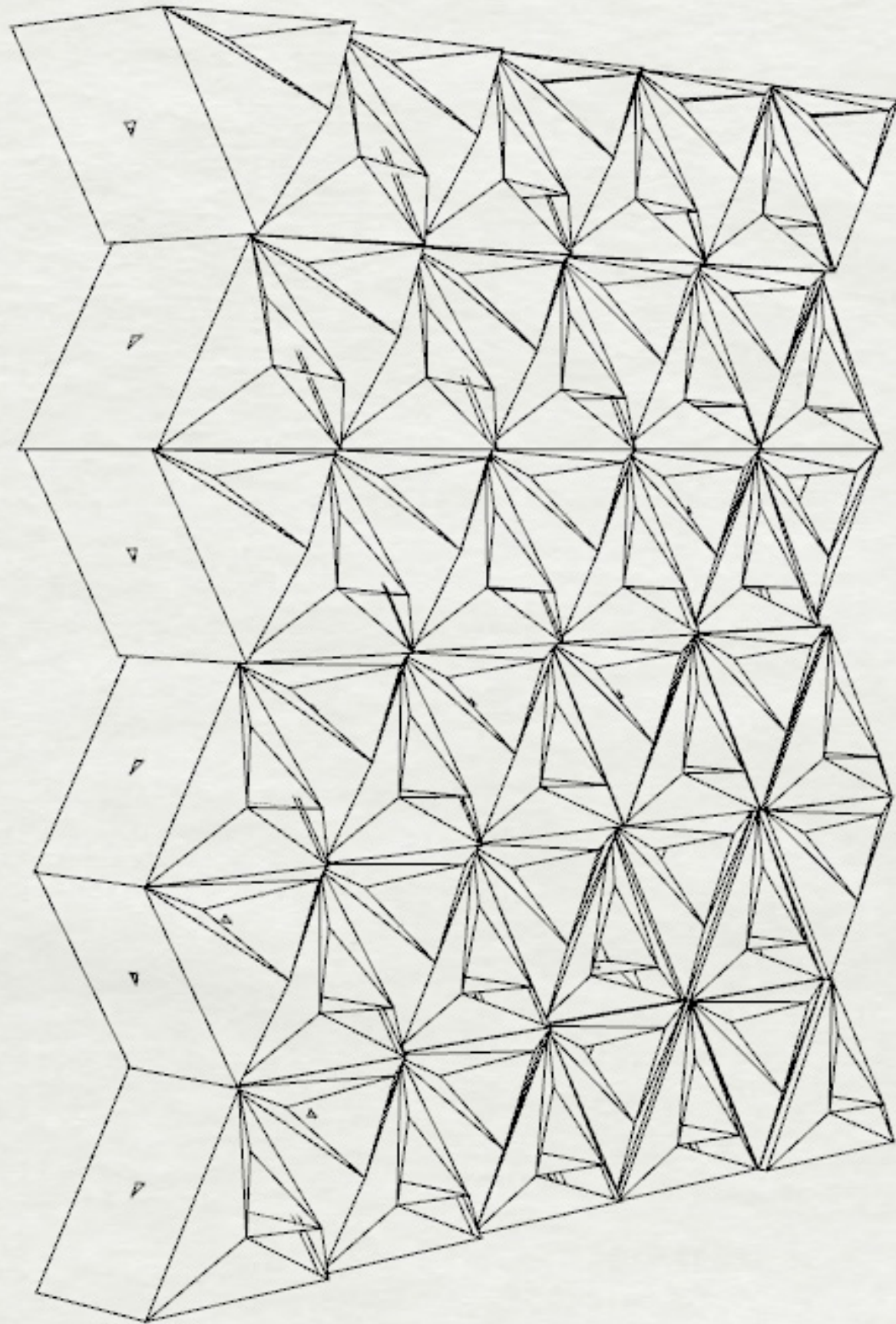

Perspective

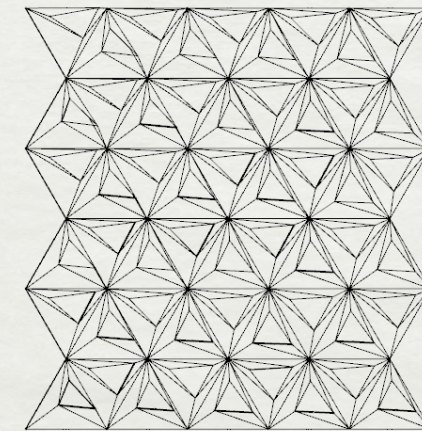

Front

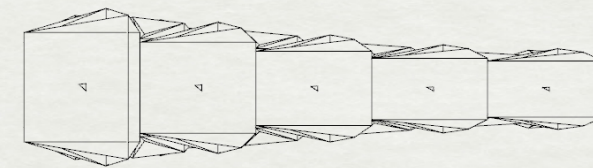

Top

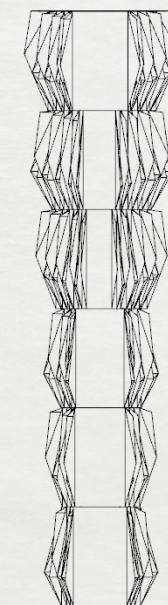

Side

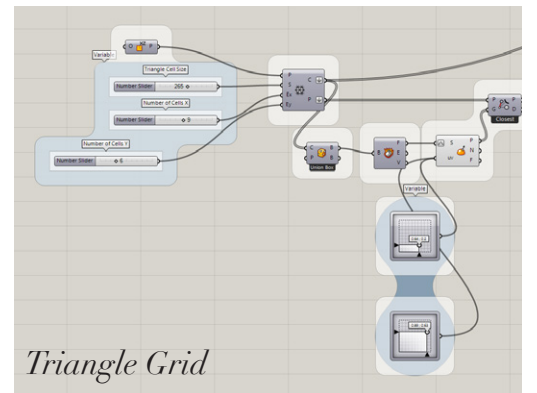

Triangle Grid

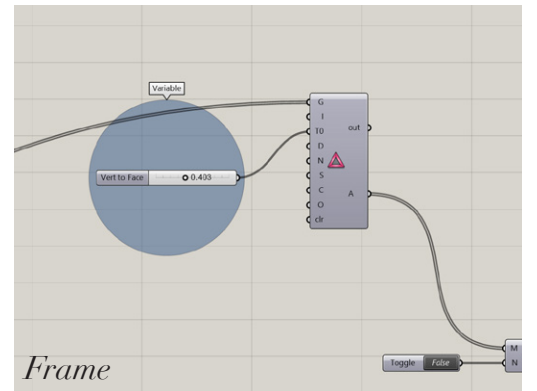

Frame

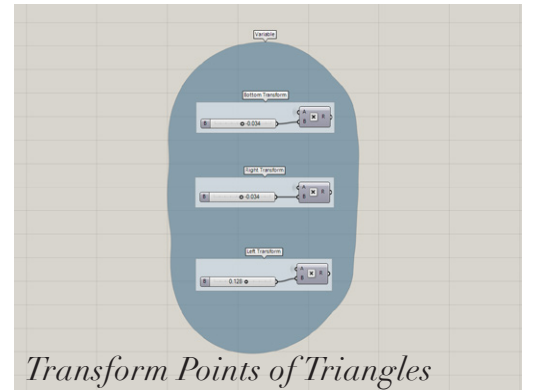

Transform Points of Triangles

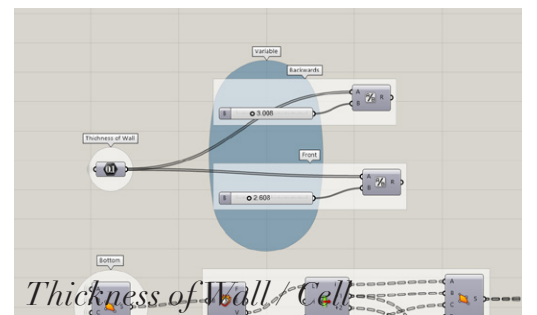

Thickness of Wall / Cell

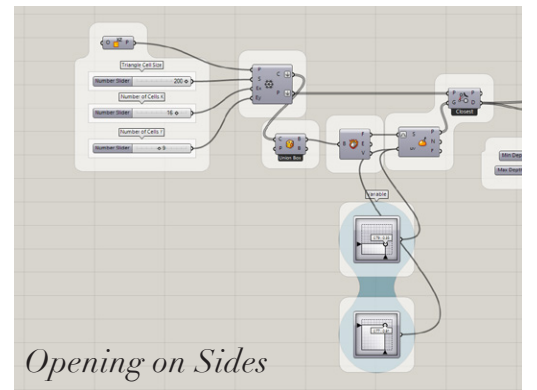

Opening on Sides

5 Variations #6

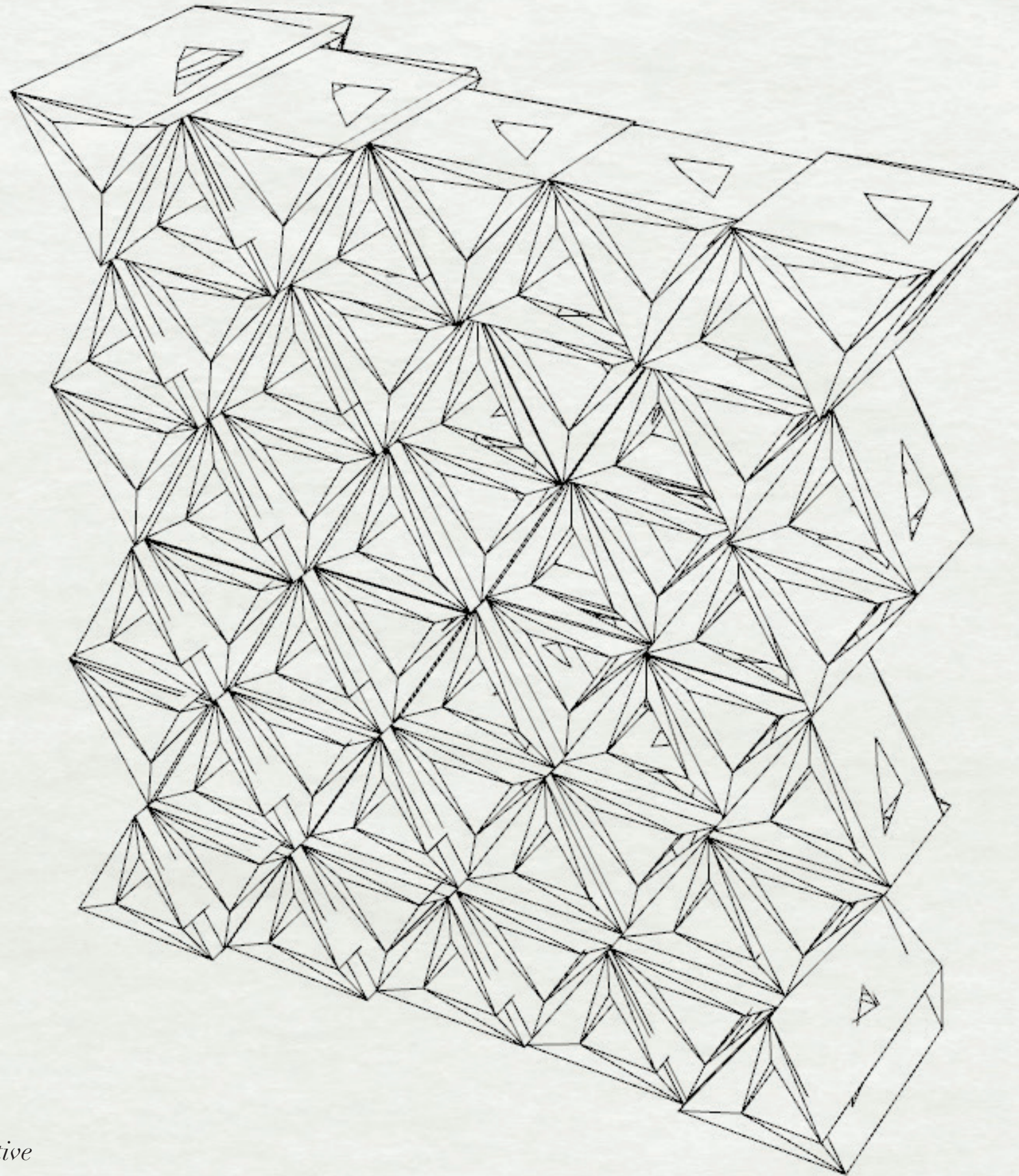

Perspective

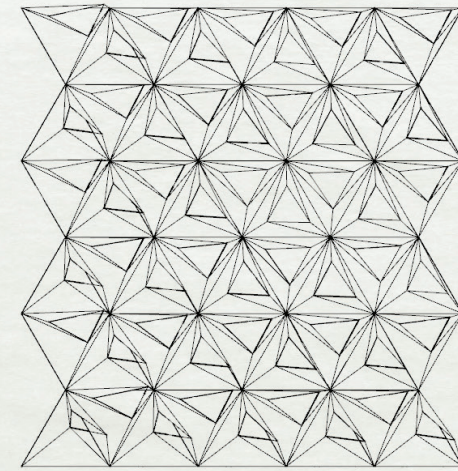

Front

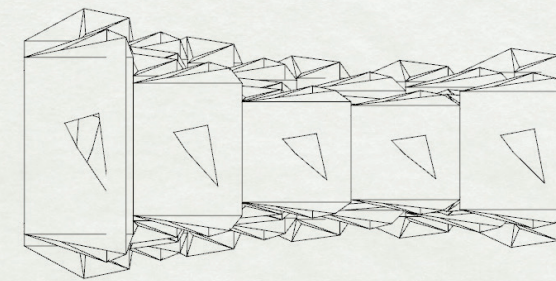

Top

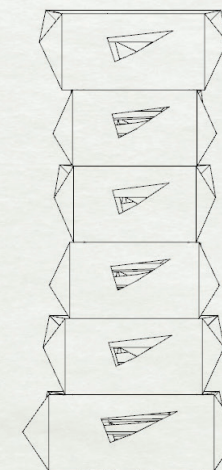

Side

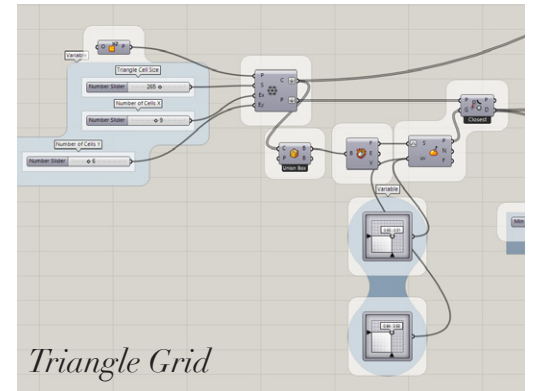

Triangle Grid

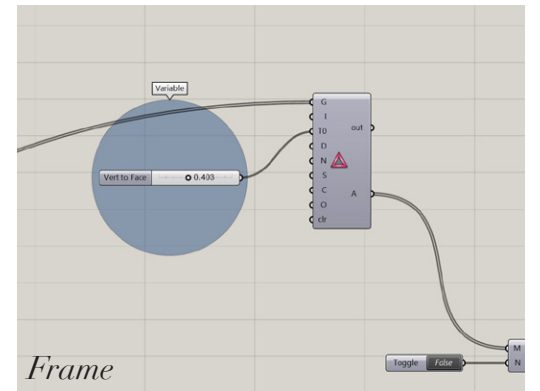

Frame

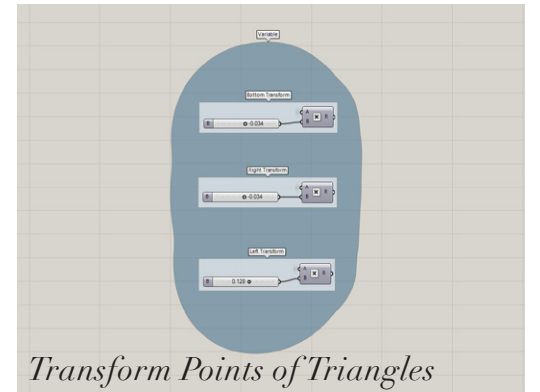

Transform Points of Triangles

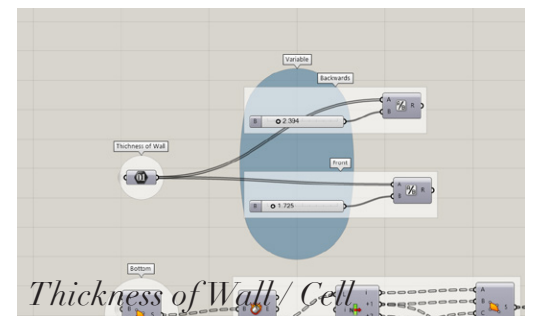

Thickness of Wall/ Cell

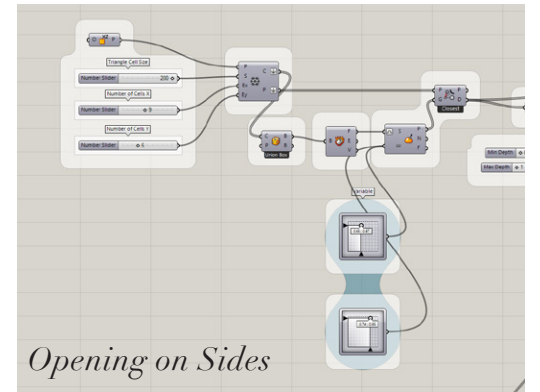

Opening on Sides

5 Variations #7

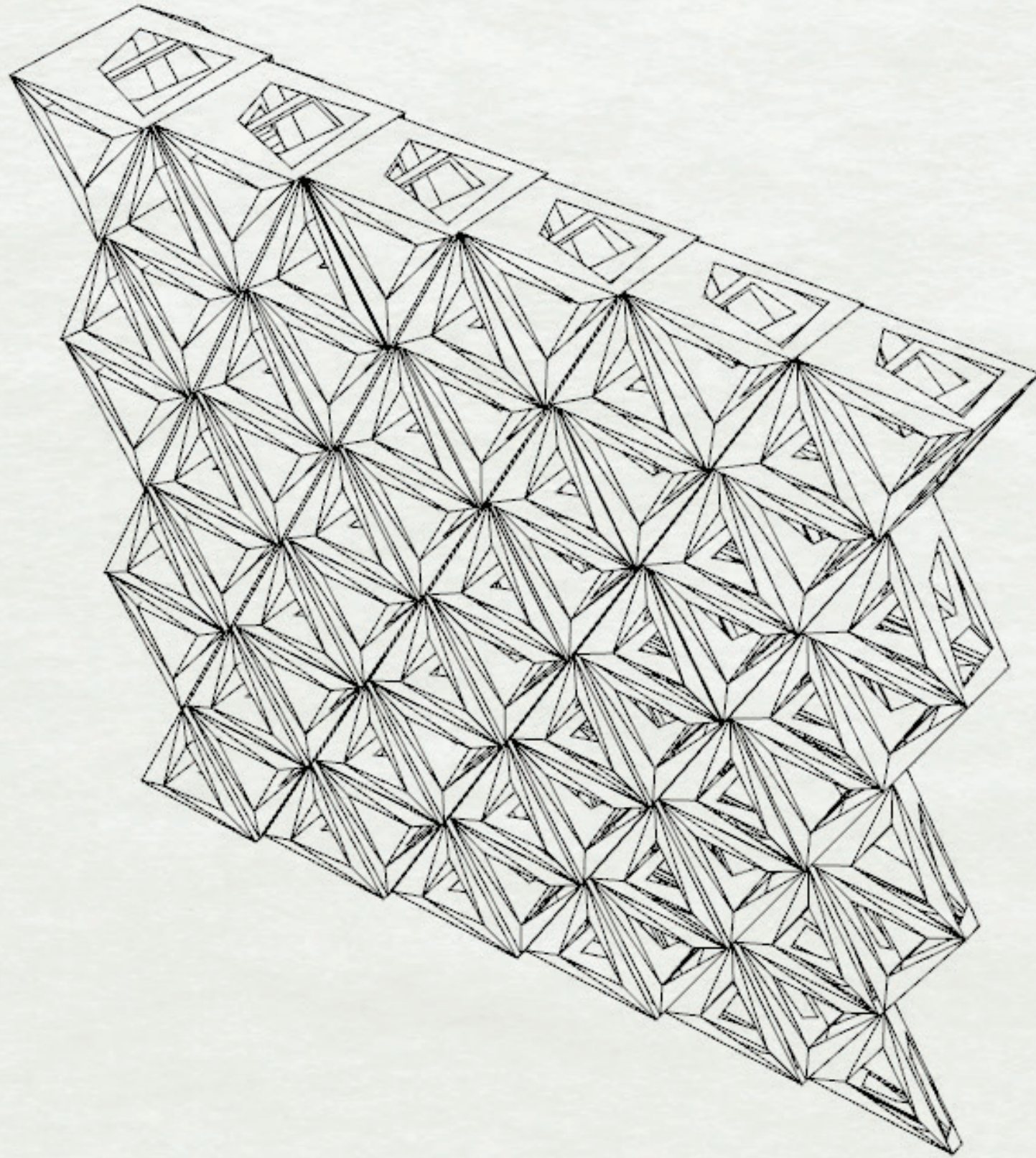

Perspective

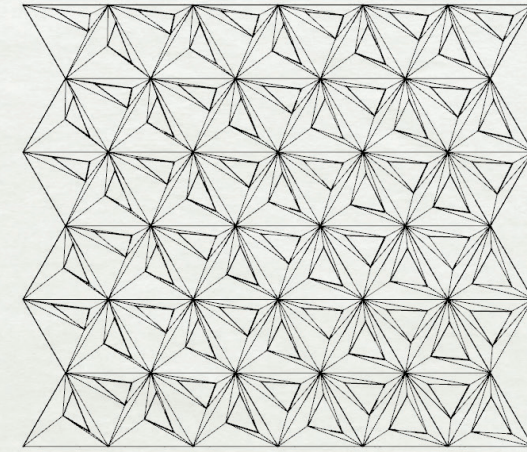

Front

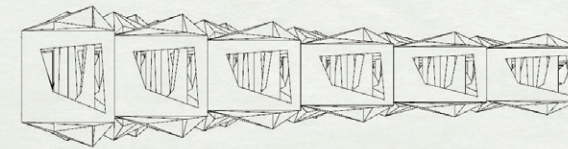

Top

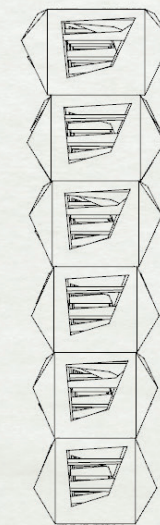

Side

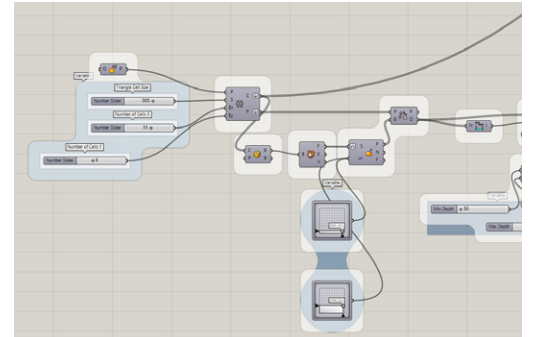

Triangle Grid

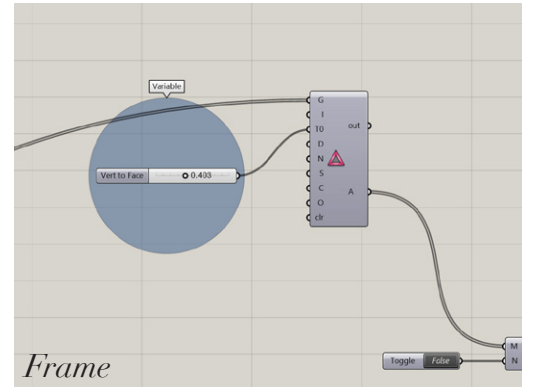

Frame

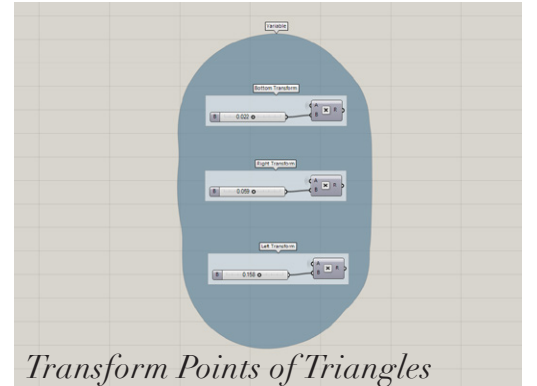

Transform Points of Triangles

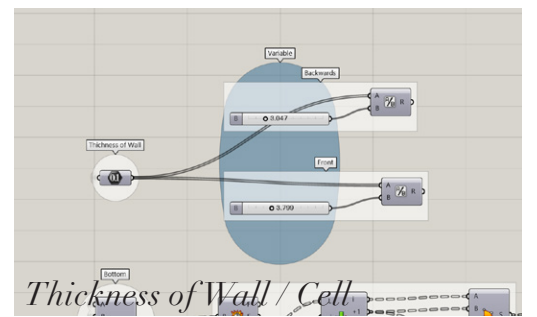

Thickness of Wall / Cell

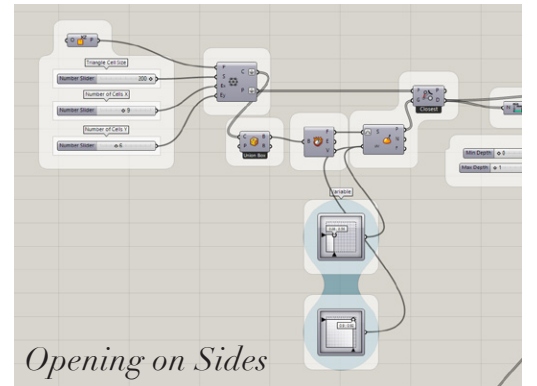

Opening on Sides

5 Variations #8

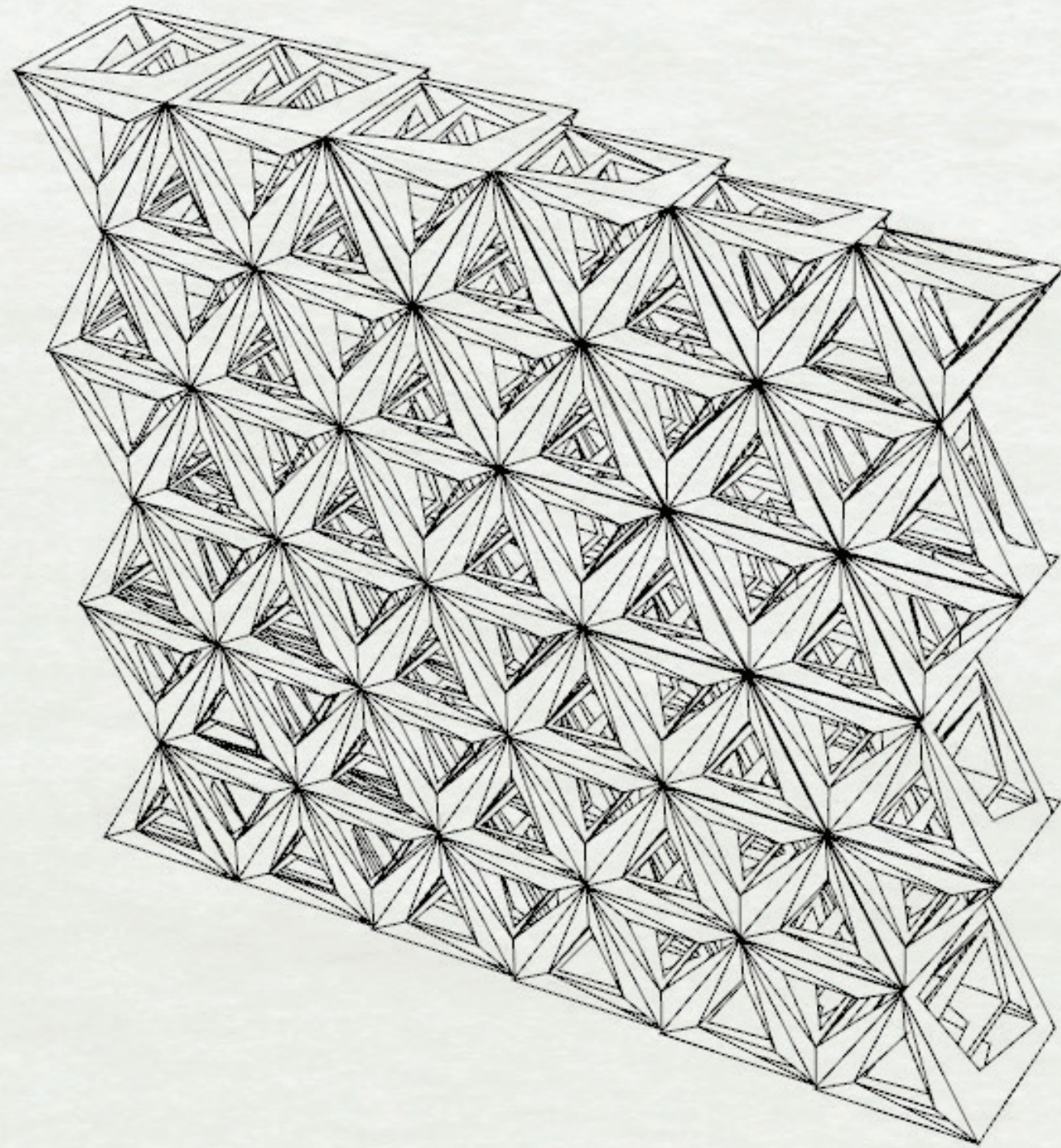

Perspective

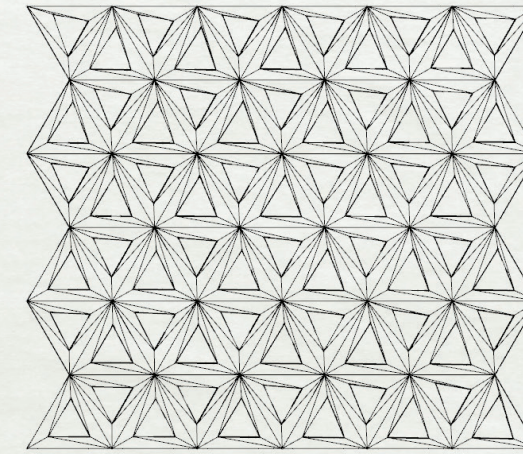

Front

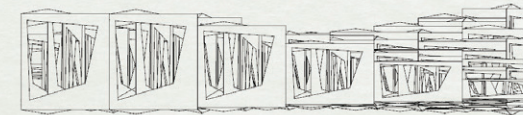

Top

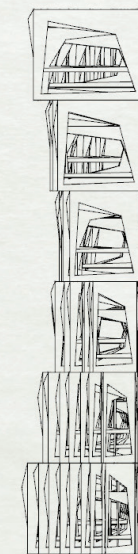

Side

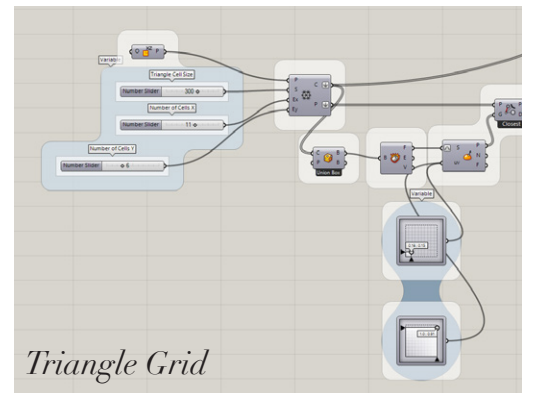

Triangle Grid

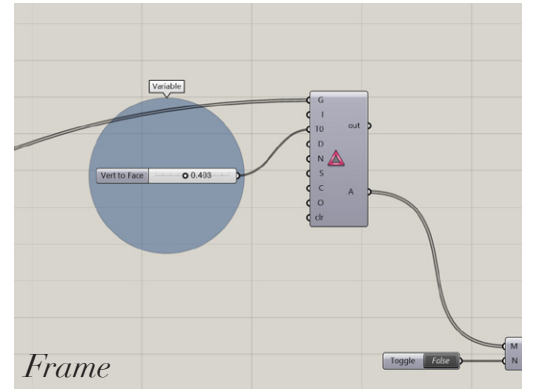

Frame

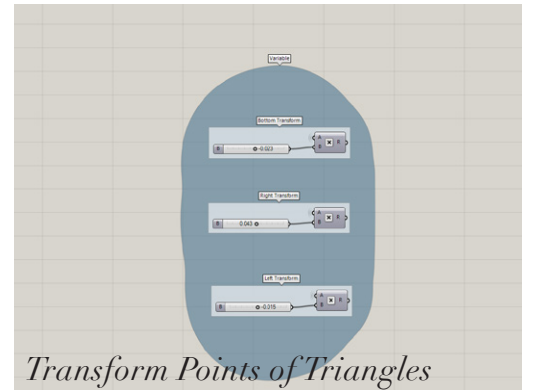

Transform Points of Triangles

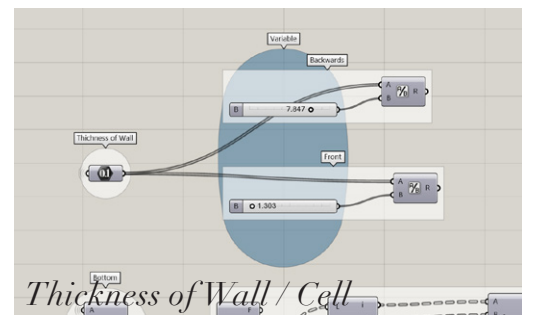

Thickness of Wall / Cell

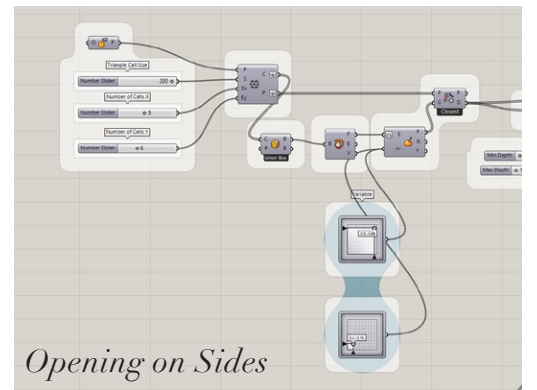

Opening on Sides

5 Variations #9

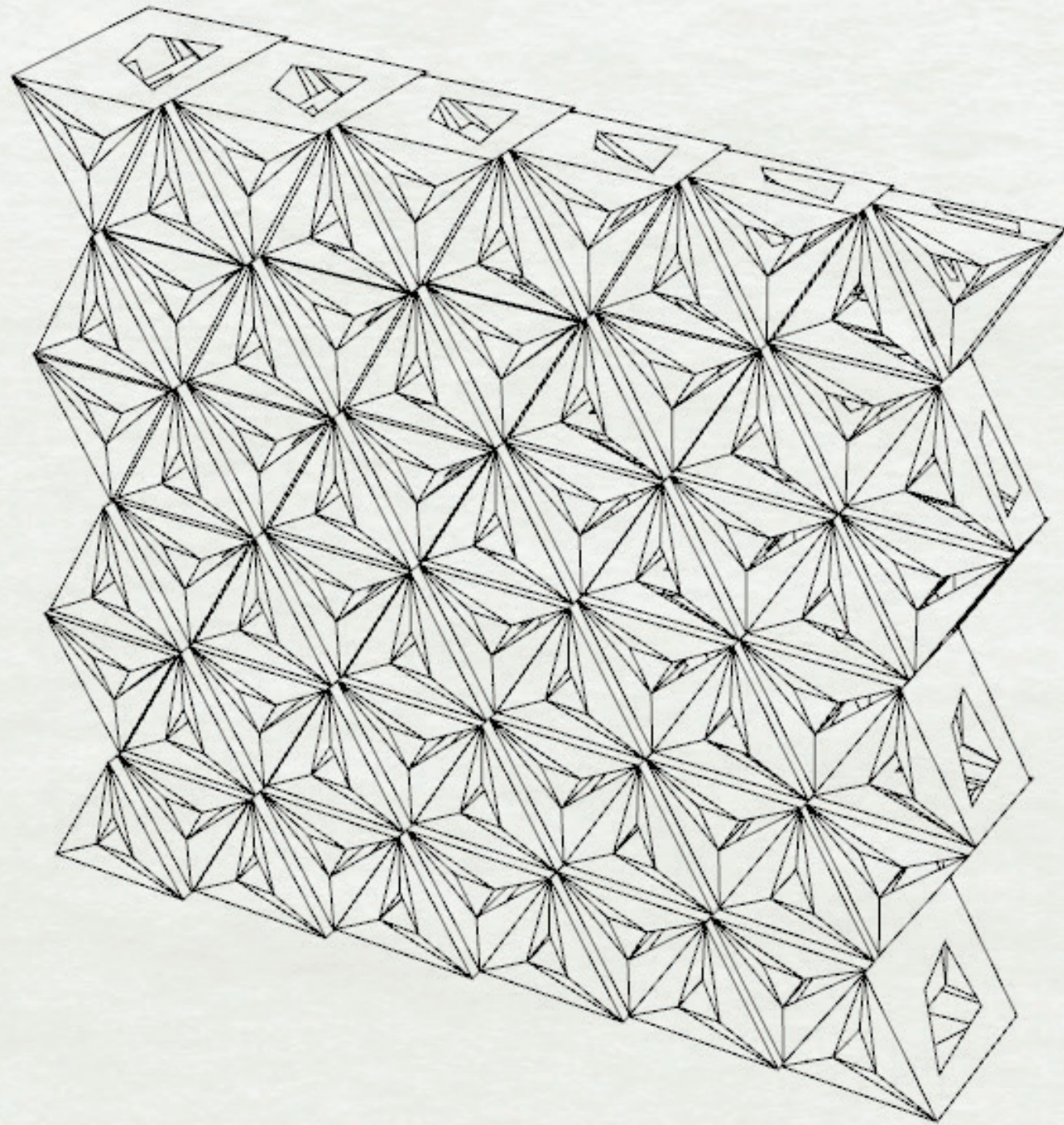

Perspective

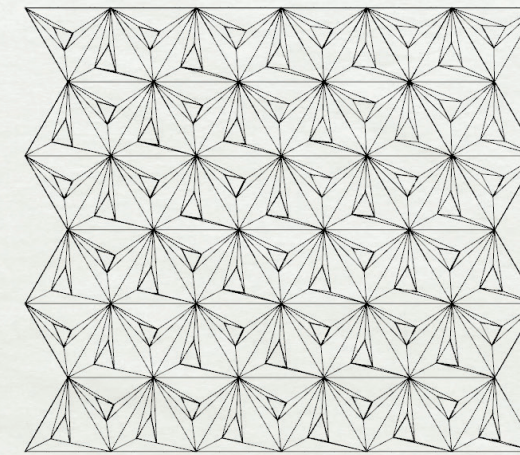

Front

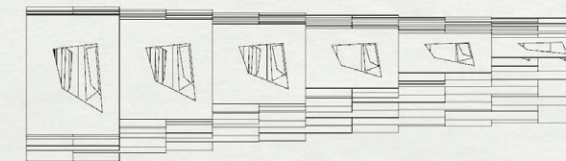

Top

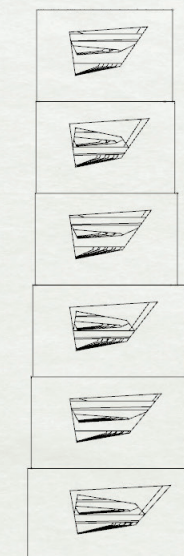

Side

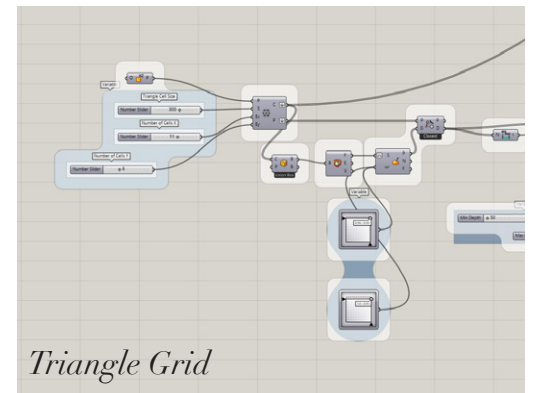

Triangle Grid

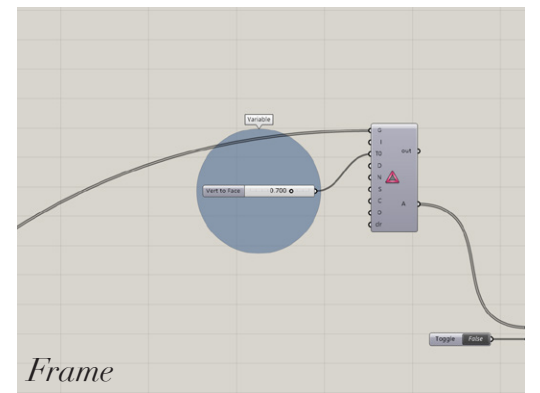

Frame

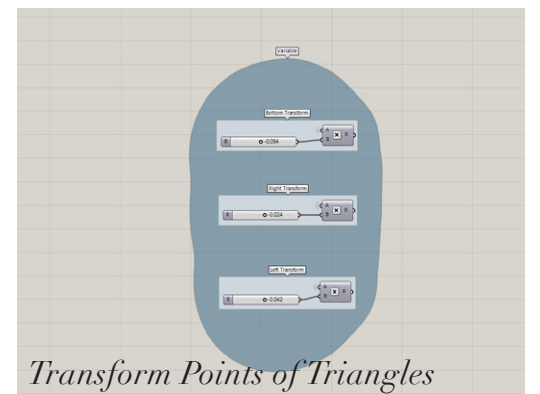

Transform Points of Triangles

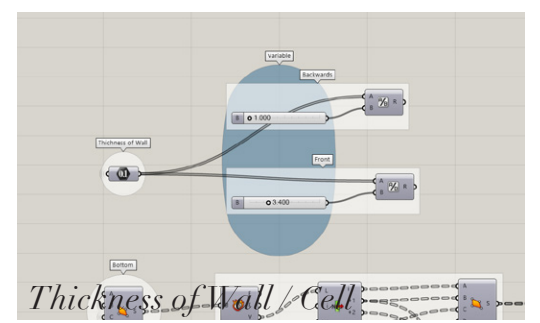

Thickness of Wall / Cell

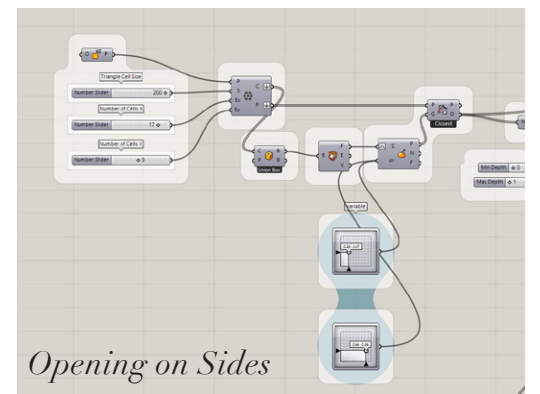

Opening on Sides

5 Variations #10

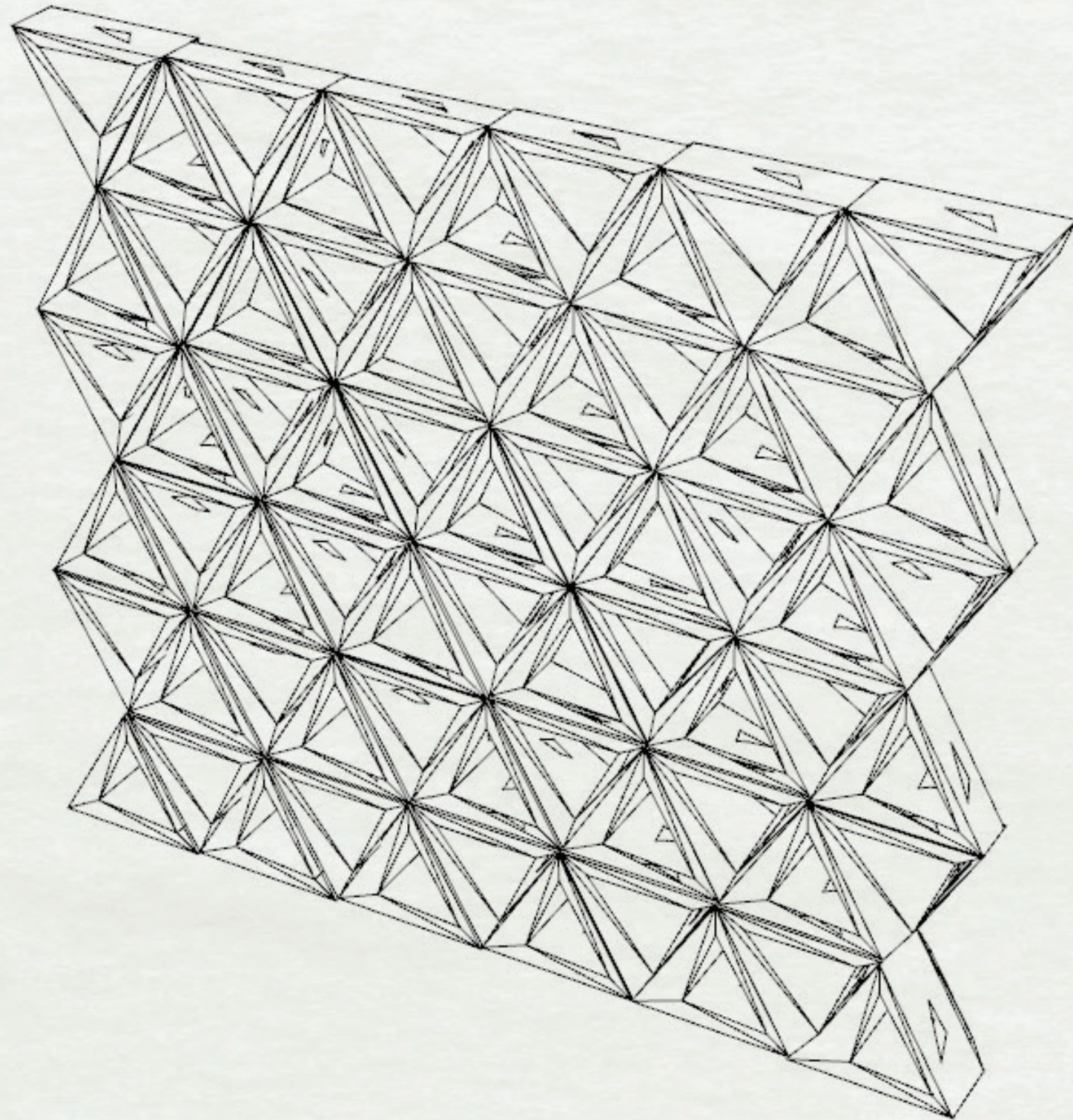

Perspective

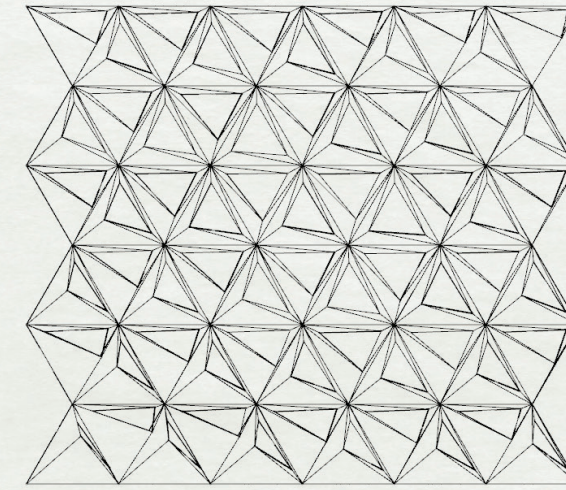

Front

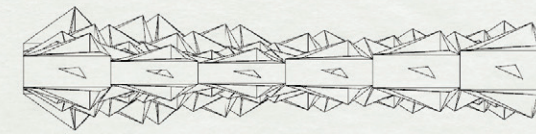

Top

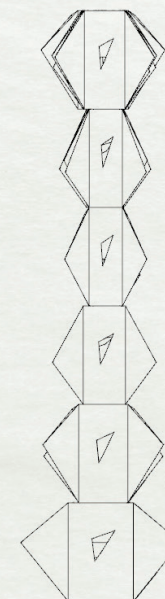

Side

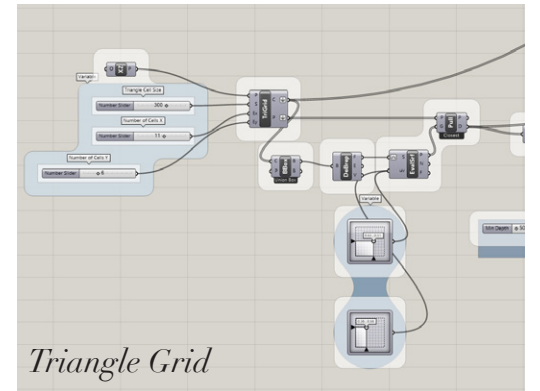

Triangle Grid

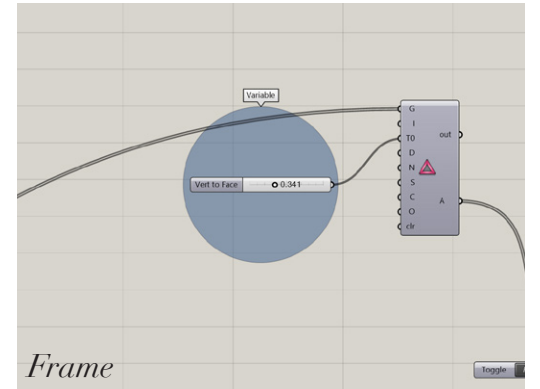

Frame

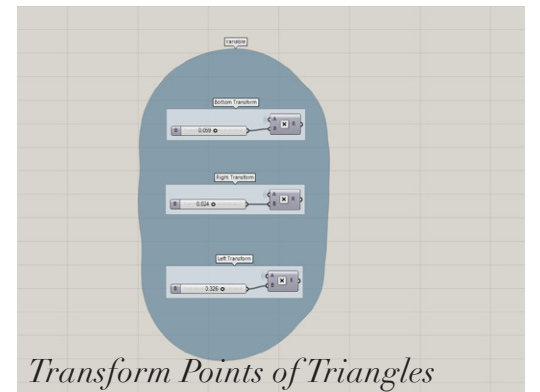

Transform Points of Triangles

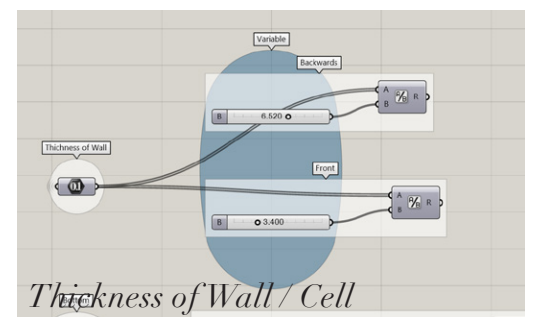

Thickness of Wall / Cell

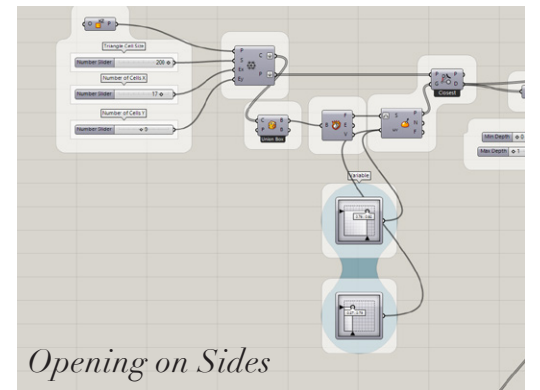

Opening on Sides

5 Variations #11

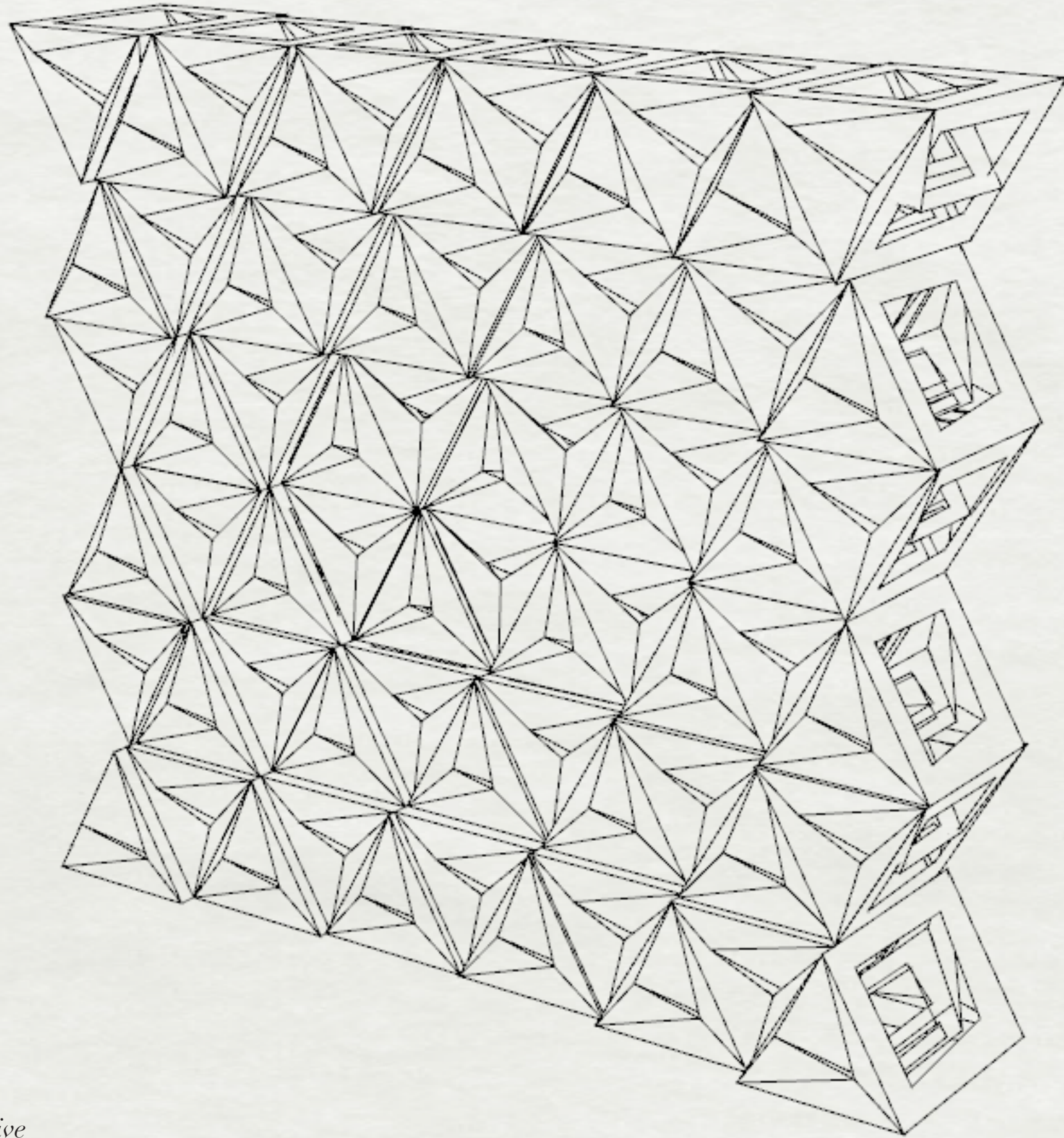

Perspective

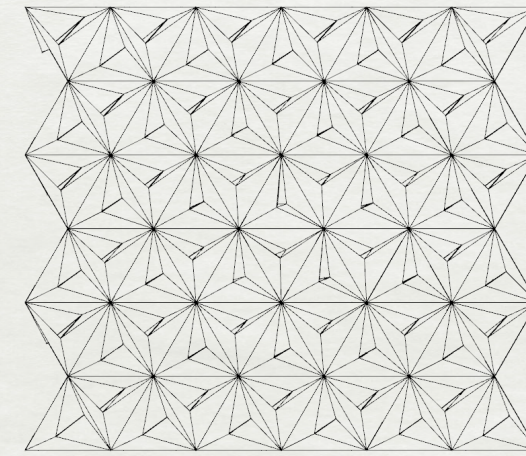

Front

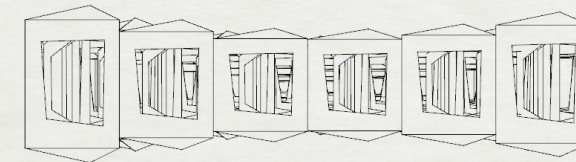

Top

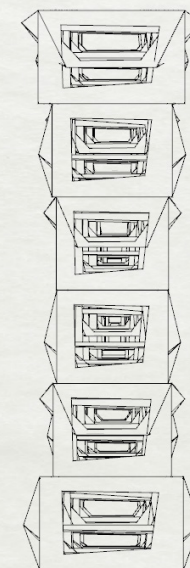

Side

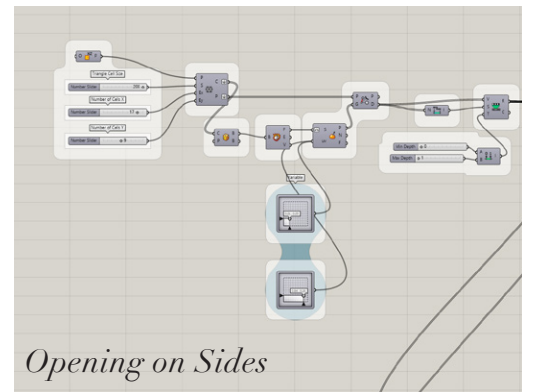
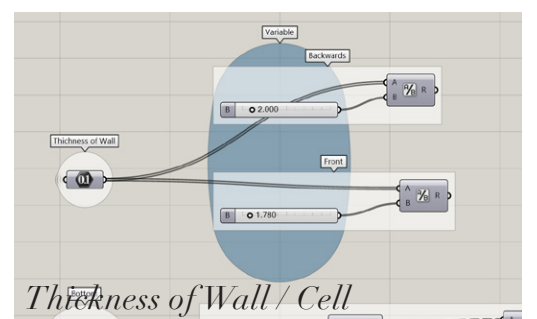
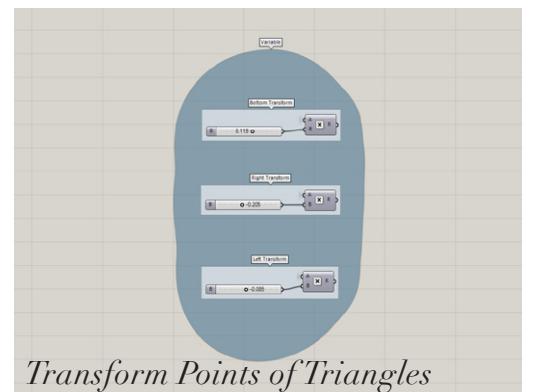
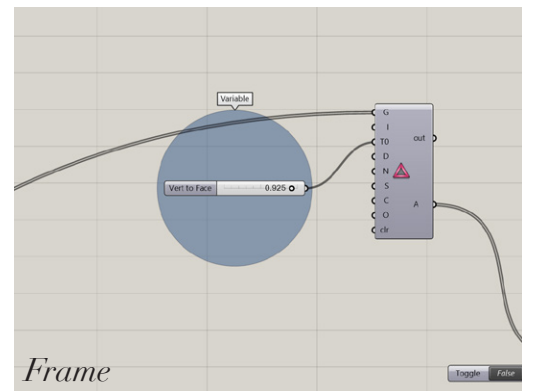
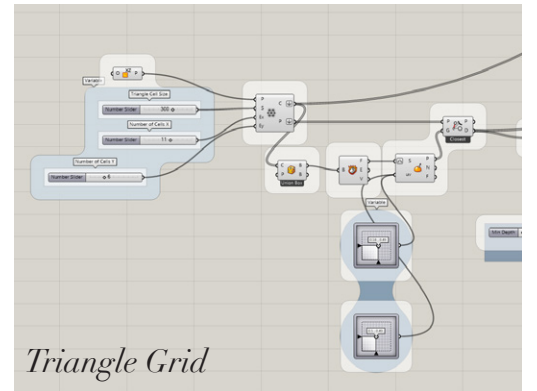

5 Variations #12

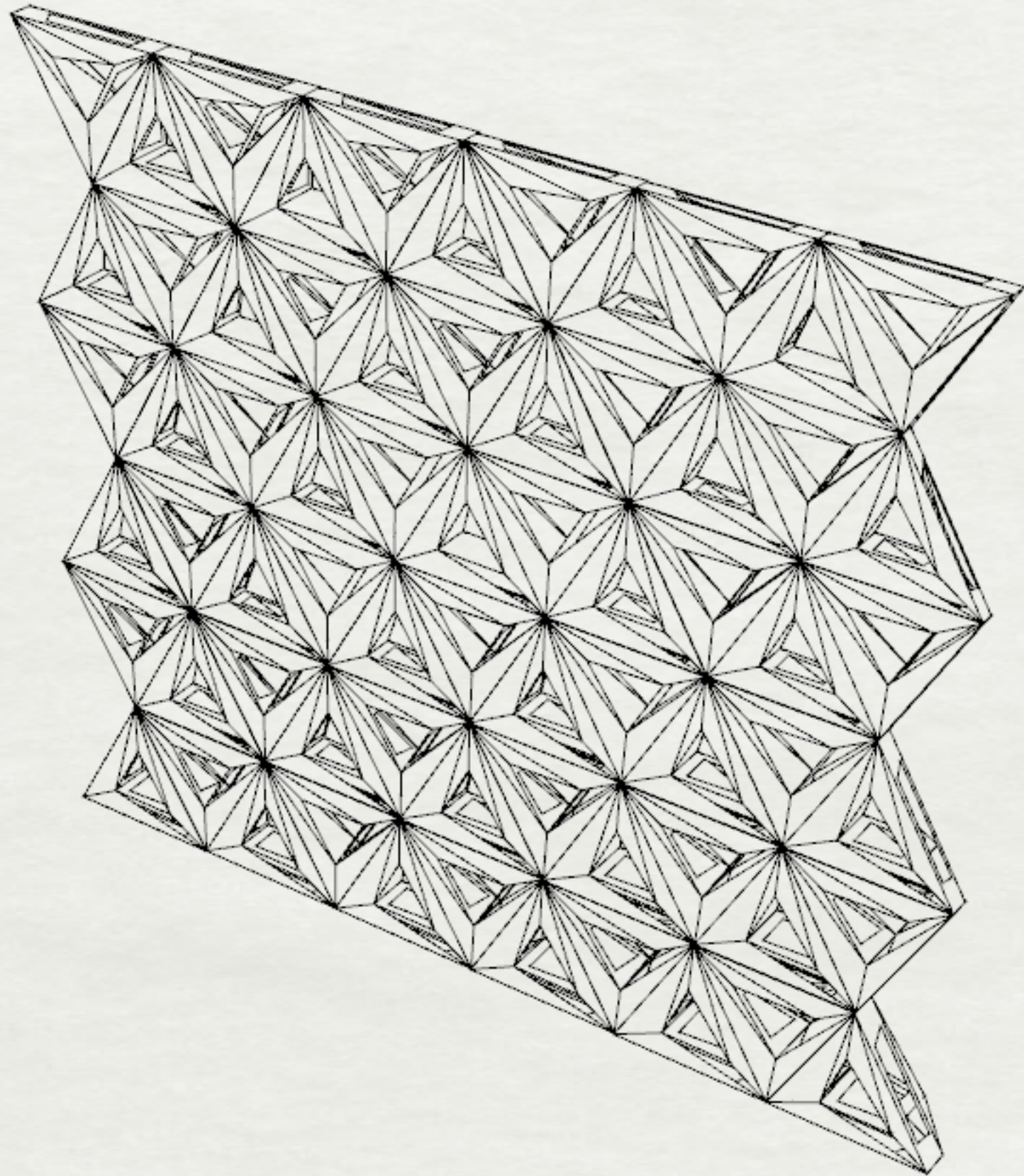

Perspective

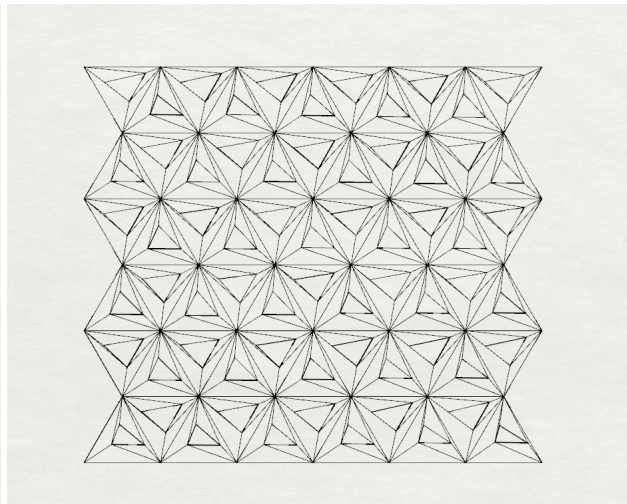

Front

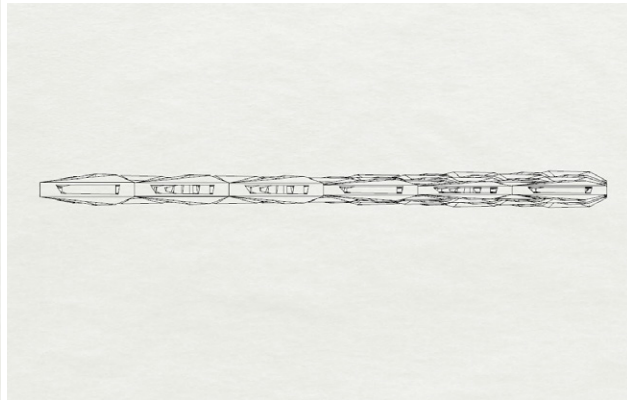

Top



Side

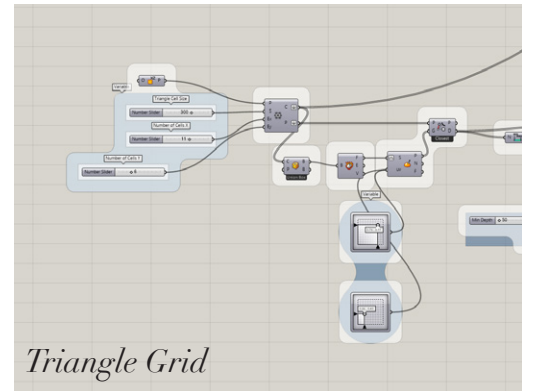

Triangle Grid

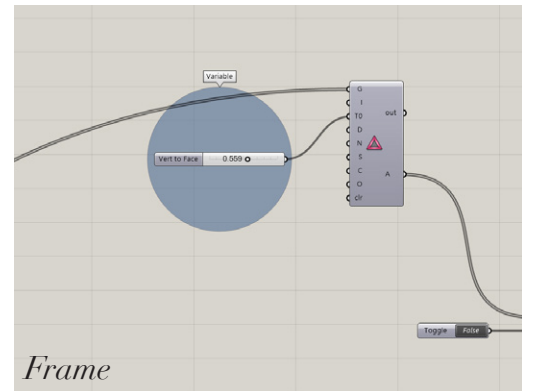

Frame

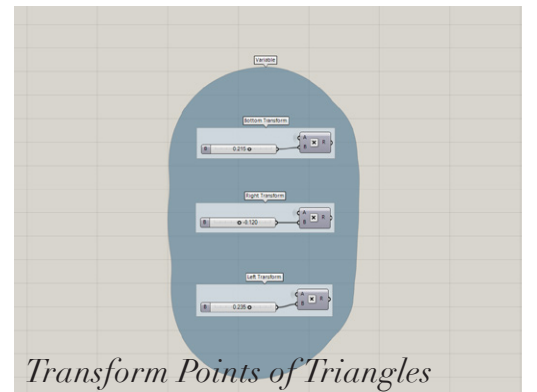

Transform Points of Triangles

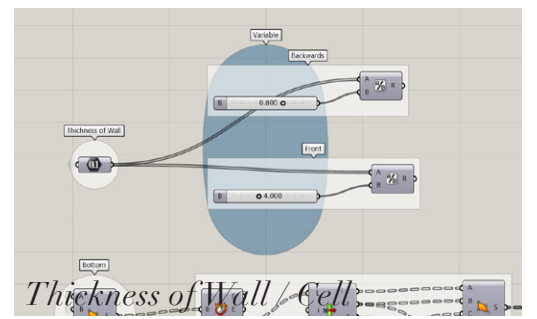

Thickness of Wall / Cell

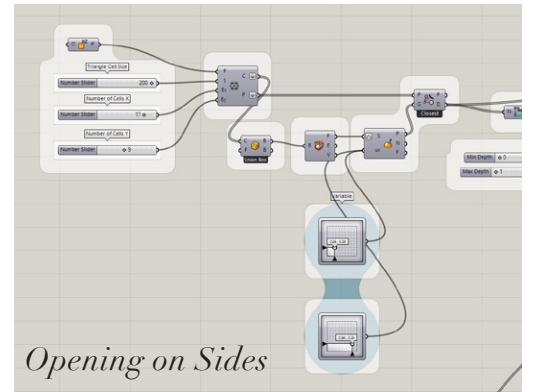

Opening on Sides

5 Variations #13

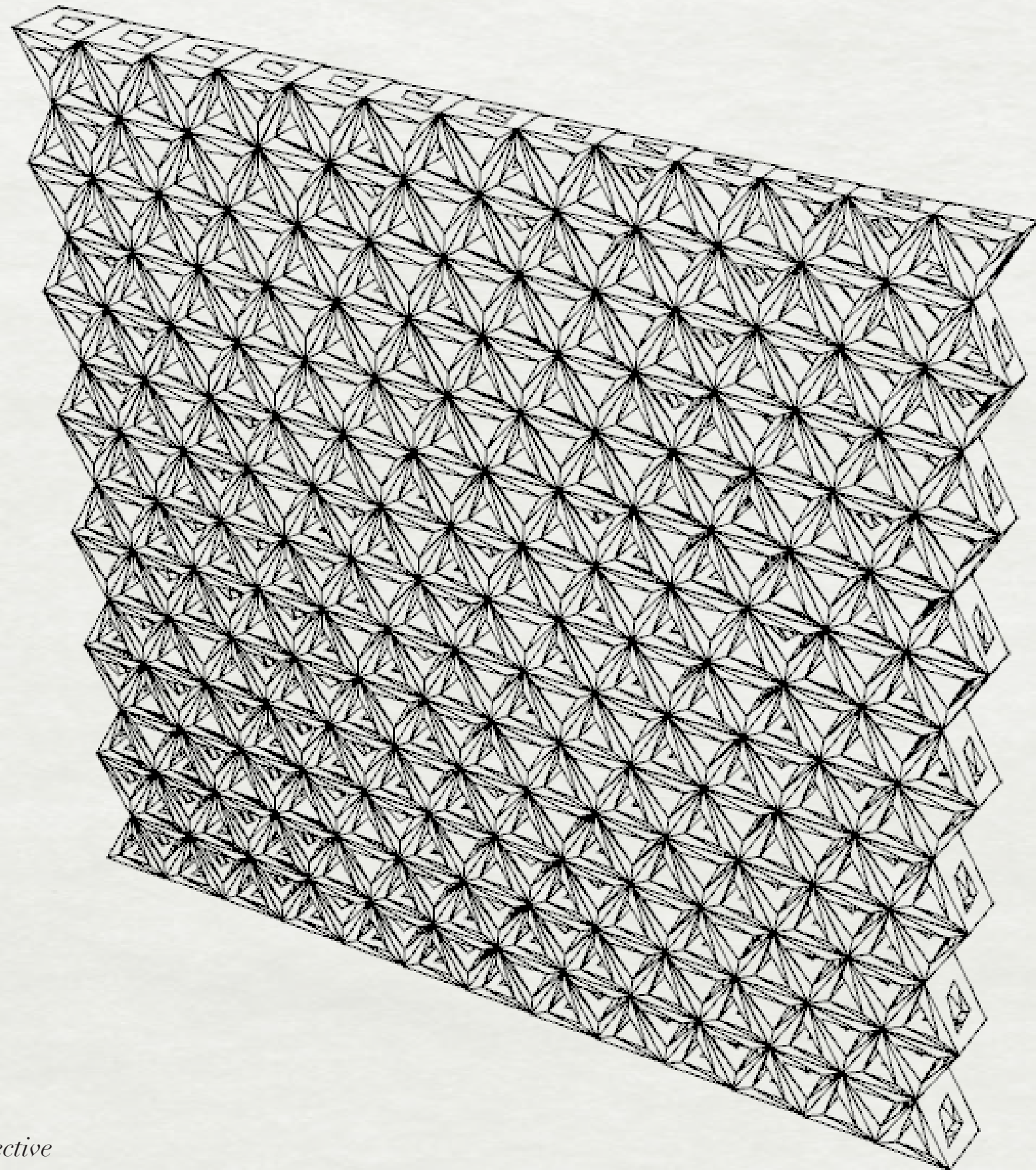

Perspective

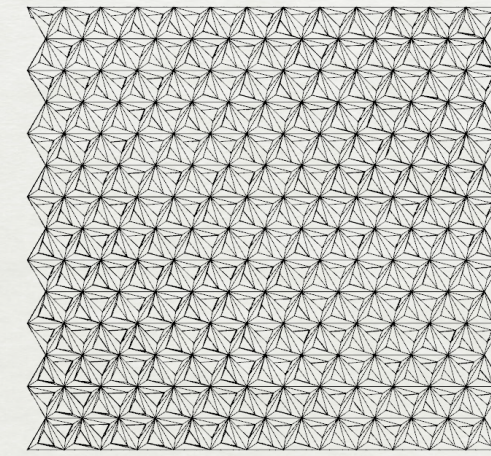

Front



Top



Side

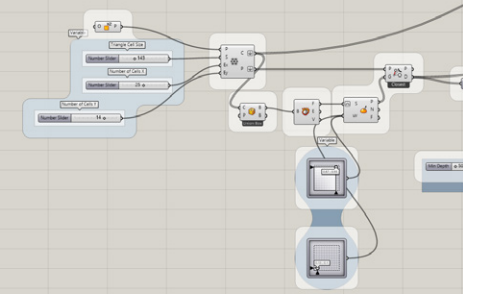

Triangle Grid

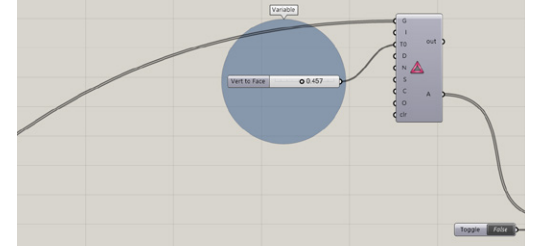

Frame

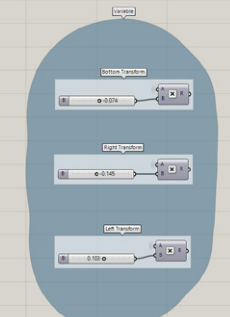

Transform Points of Triangles

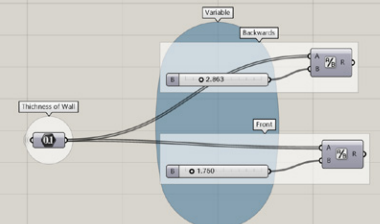

Thickness of Wall / Cell

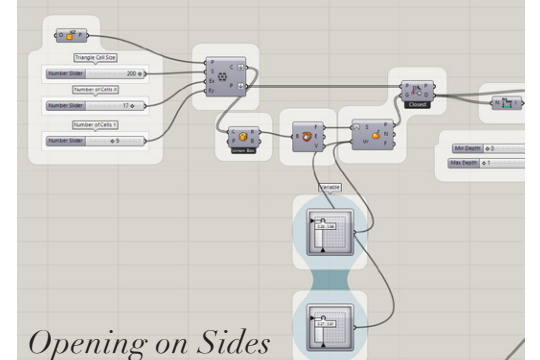

Opening on Sides

5 Variations #14

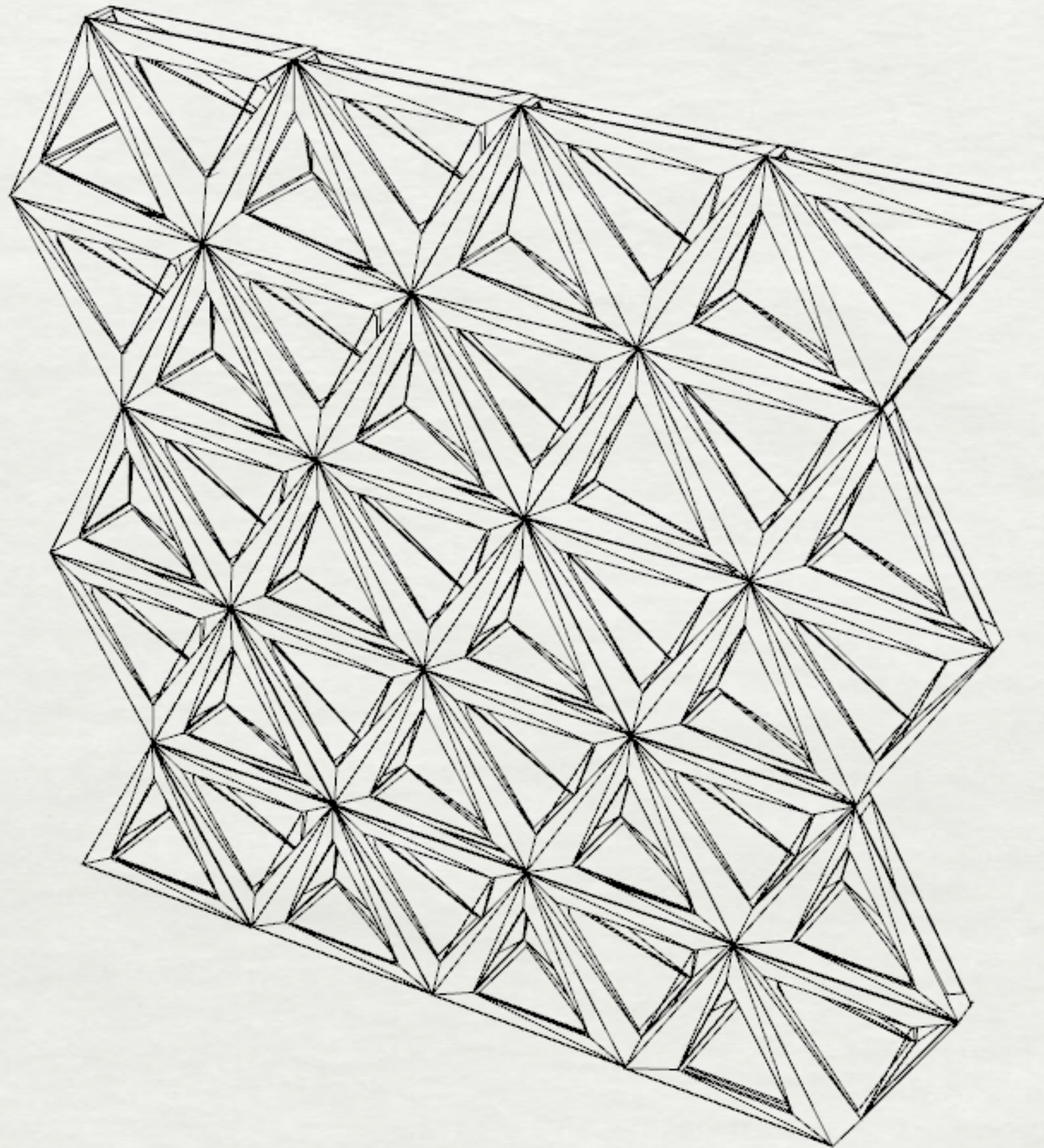

Perspective

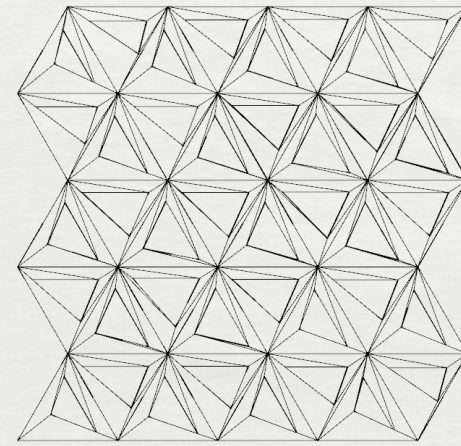

Front



Top



Side

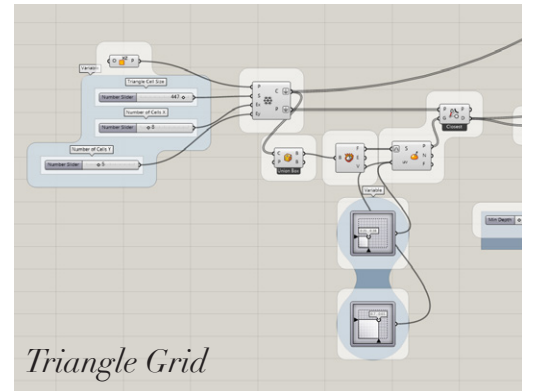

Triangle Grid

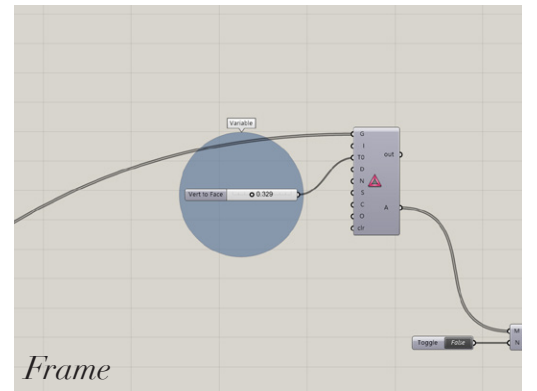

Frame

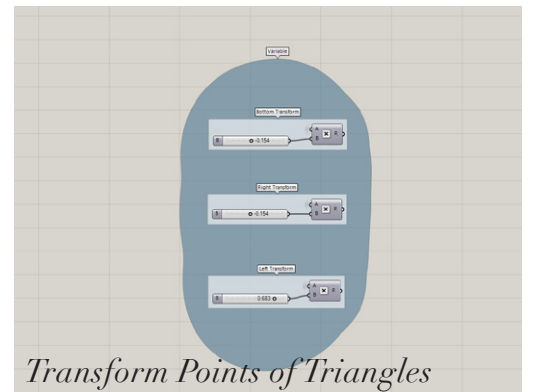

Transform Points of Triangles

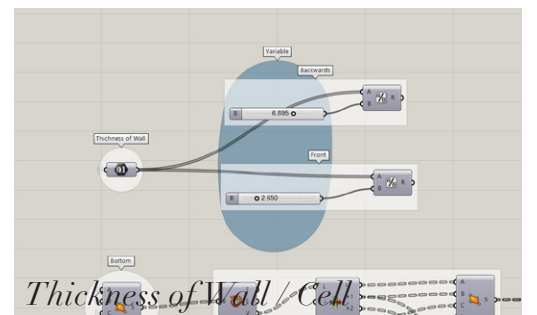

Thickness of Wall / Cell

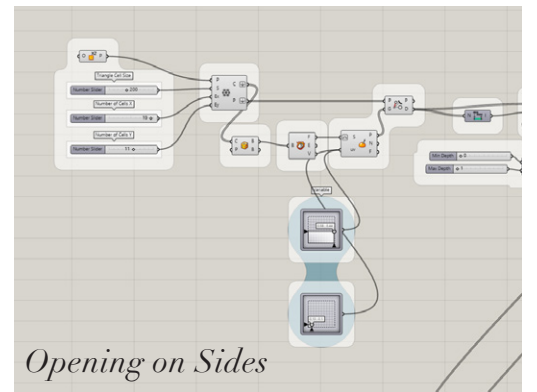

Opening on Sides

5 Variations #15

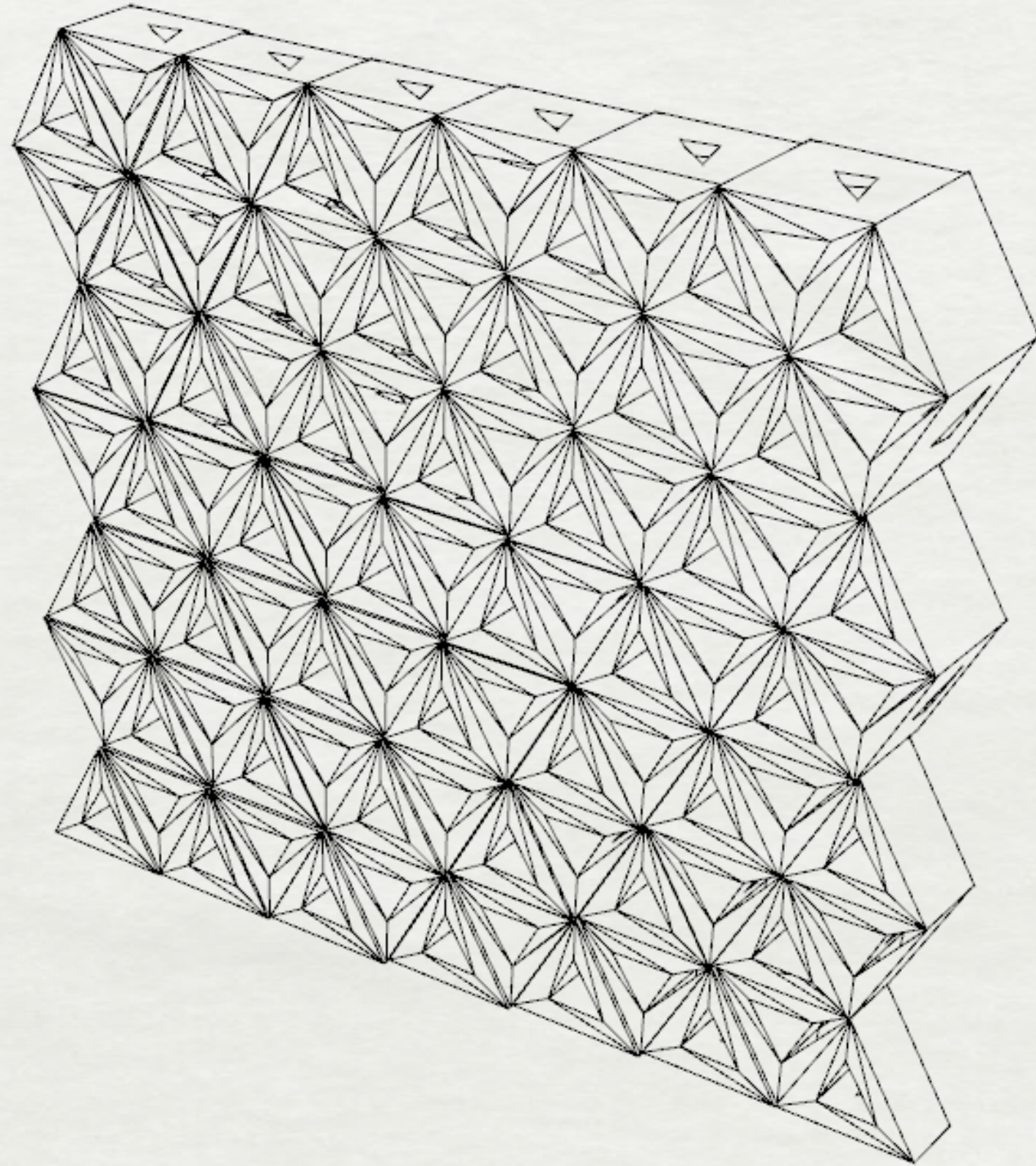

Perspective

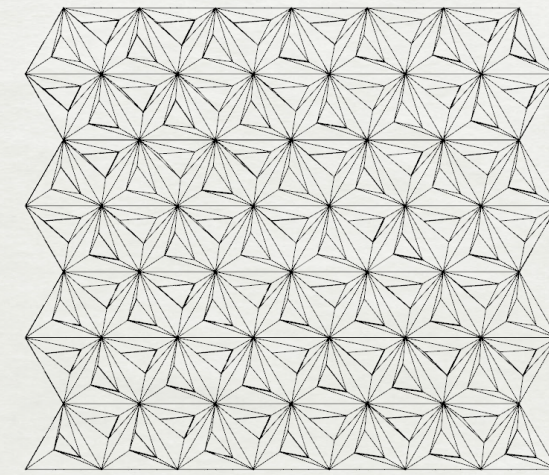

Front

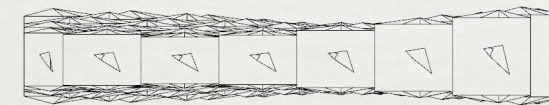

Top

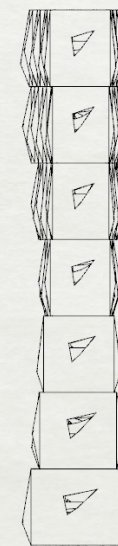

Side

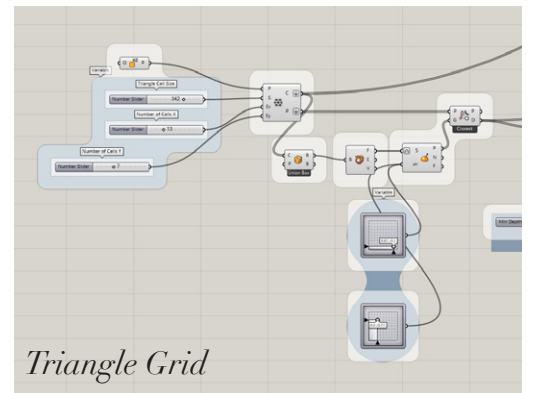

Triangle Grid

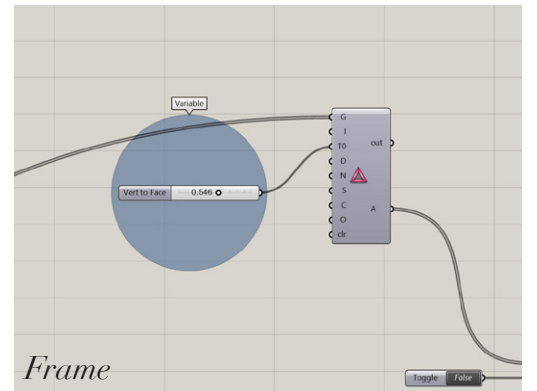

Frame

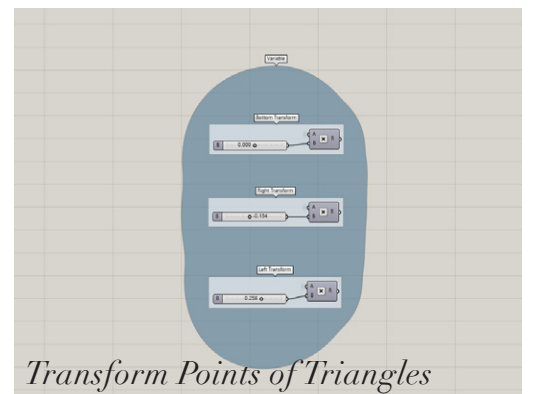

Transform Points of Triangles

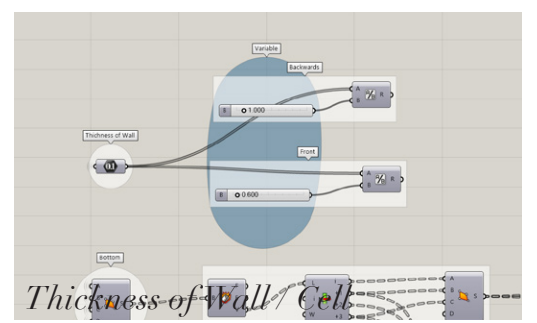

Thickness of Wall/Cell

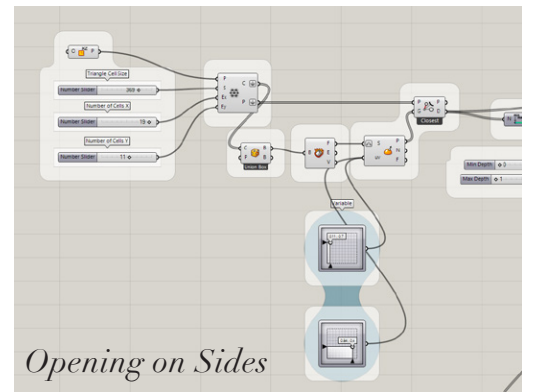

Opening on Sides